



Abridged user's manual (Canada version)

LS6195/LS6195-13/LS6195-15/ LS6195-16/LS6195-17 DECT 6.0 cordless telephone



Telephones identified with this logo have reduced noise and interference when used with most T-coil equipped hearing aids and cochlear implants. The TIA-1083 Compliant Logo is a trademark of the Telecommunications Industry Association. Used under license.

Introduction

To help protect the environment, this Abridged user's manual provides you with the basic installation and use instructions. A limited set of features are described in abbreviated form.

Please refer to the online Complete user's manual for a full set of installation and operation instructions at www.vtechcanada.com.

Before using this VTech product, please read **Important safety instructions** on page 11 of this user's manual.

Parts checklist

Your telephone package contains the following items. Save your sales receipt and original packaging in the event warranty service is necessary.



Handset



Telephone base



Telephone line cord

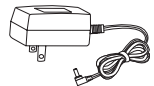

Telephone base power adapter



Battery compartment cover



Battery

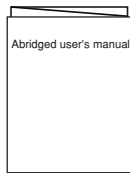

Abridged user's manual



Quick start guide

Telephone base installation

Install the telephone base as shown below.

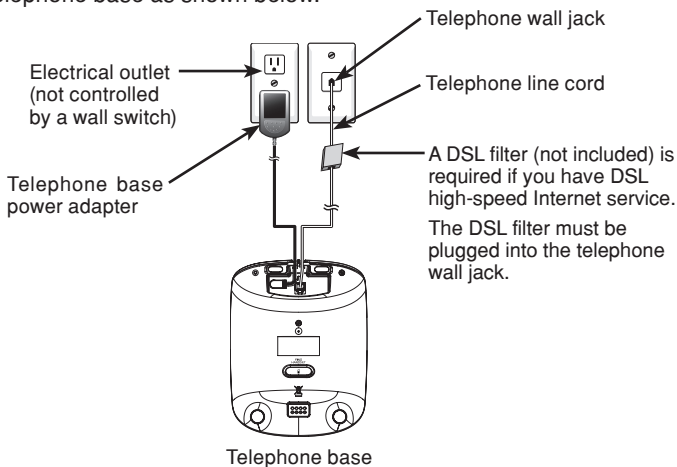

note

Use only the power adapter and battery supplied with this product. To order a replacement, visit our website at www.vtechcanada.com or call 1 (800) 267-7377.

Battery installation

Install the battery as shown below.

1. Insert the battery connector securely into the socket as shown below.
2. Place the battery with the label **THIS SIDE UP** facing up and the wires inside the battery compartment.

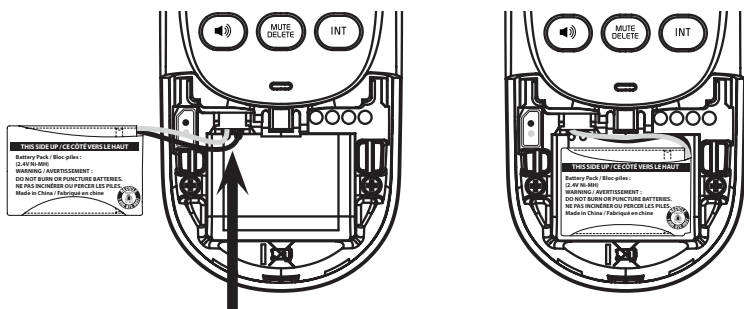

3. Slide the battery compartment cover towards the center of the handset until it clicks into place.
4. Place the handset in the telephone base to charge.

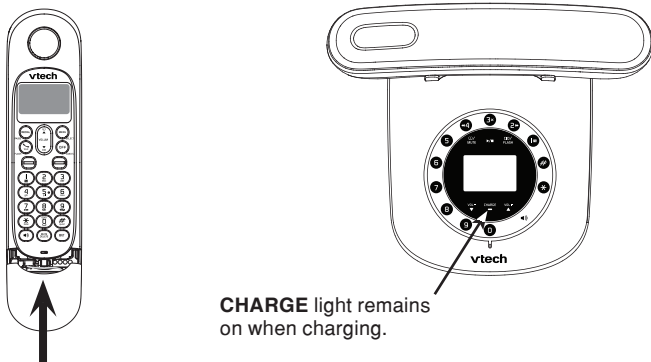

Battery charging

Once you have installed the battery, the screen indicates the battery status (see the table below). For best performance, keep the handset in the telephone base when not in use. The battery is fully charged after 11 hours of continuous charging.

Battery indicators	Battery status	Action
The screen is blank, or displays Put in charger and flashes.	The battery has no or very little charge. The handset cannot be used.	Charge without interruption (at least 30 minutes).
The screen displays Low battery and flashes.	The battery has enough charge to be used for a short time.	Charge without interruption (about 30 minutes).
The screen displays HANDSET 1 .	The battery is charged.	To keep the battery charged, place it in the telephone base when not in use.

Handset overview

/VOLUME

- Review the directory when the phone is not in use.
- Increase the listening volume during a call or message playback.
- Scroll up while in a menu, or in the directory, caller ID log or redial list.
- Move the cursor to the right when entering numbers or names.

REDIAL/PAUSE

- Press repeatedly to review the redial list.
- Press and hold to insert a dialing pause while dialing or entering a number.

/FLASH

- Make or answer a call.
- Answer another incoming call during a call.

1/

- Press repeatedly to add or remove 1 in front of the caller ID log entry before dialing or saving it to the directory.
- Press and hold to set or dial your voicemail number.

Dialing keys

- Enter numbers or characters.
- Answer an incoming call.

- Switch to tone dialing temporarily during a call.

- Make or answer a call using the handset speakerphone.
- During a call, press to switch between the speakerphone and the handset.

CID//VOLUME

- Review the caller ID log when the phone is not in use.
- Decrease the listening volume during a call or message playback.
- Scroll down while in a menu, or in the directory, caller ID log or redial list.
- Move the cursor to the left when entering numbers or names.

MENU/SELECT

- Show the menu.
- While in a menu, press to select an item, or save an entry or setting.

OFF/CANCEL

- Hang up a call.
- Silence the ringer temporarily while the handset is ringing.
- Press and hold to erase the missed call indicator while the handset is not in use.
- Press to return to the previous menu, or press and hold to return to idle mode, without making changes.

quiet

- Press and hold to set and turn on the quiet mode, or turn it off.
- Press repeatedly to show other dialing options when reviewing a caller ID log entry.

INT

- Start an intercom conversation or transfer a call.

MUTE/DELETE

- Mute the microphone during a call.
- Delete digits or characters while using the dialing keys.
- Silence the ringer temporarily while the handset is ringing.
- Delete the displayed entry while in the directory, caller ID log or redial list.

Telephone base overview

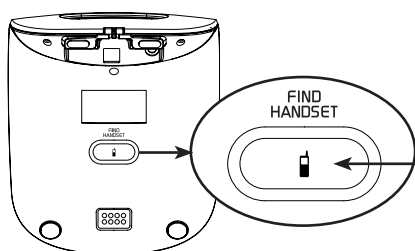

/FIND HANDSET

Press to page the system handset.

Bottom of the telephone base

Telephone base overview (continued)

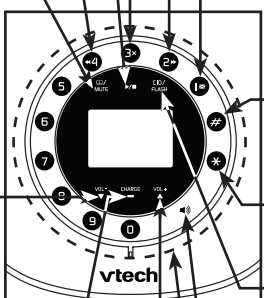

▶/■

- Tap to play or stop playing messages.

◀4

- Press to repeat the playing message.
- Press twice to play the previous message.

📖/MUTE

- Tap to review the directory when the phone is not in use.
- Tap to return to idle mode while in the directory.
- Tap to mute the microphone during a call.
- Tap to silence the ringer temporarily while the telephone base is ringing.

VOL-/▼

- Tap to decrease the listening volume during a call and message playback.
- Tap to decrease the telephone base ringer volume when the phone is not in use.
- Tap to scroll down while in the directory or caller ID log.
- Tap to delete digits or characters while predialing.

CHARGE light

- On when the handset is charging.

VOL+/▲

- Tap to increase the listening volume during a call and message playback.
- Tap to increase the telephone base ringer volume when the base is not in use.
- Tap to scroll up while in the directory or caller ID log.

3x

- Press to delete the playing message.

2▶

- Press to skip to the next message.

1✉

- Press repeatedly to add or remove 1 in front of the caller ID log entry before dialing or saving it to the directory.
- **Press and hold** to dial your voicemail number.

#

- Press repeatedly to show other dialing options when reviewing a caller ID log entry.

***✳**

- Press to switch to tone dialing temporarily during a call.

CID/FLASH

- Tap to review the caller ID log when the phone is not in use.
- Tap to return to idle mode while in the caller ID log.
- Tap to answer another incoming call during a call.

📞

- Press to make, answer or end a call using the telephone base.

Dialing keys (0-9, # & ✳)

- Press to enter numbers or characters.
- Press to answer an incoming call.

Using the handset menu

1. Press **MENU** when the handset is not in use.
 2. Press **▼** or **▲** until the screen displays the desired feature menu.
 3. Press **SELECT**.
- To return to the previous menu, press **CANCEL**.
 - To return to idle mode, **press and hold CANCEL**.

Telephone settings

Default settings are indicated by asterisks (*).

Settings menu	Description	Options
LCD language	Set the handset display language.	English* Français Español
Base LCD lang	Set the telephone base display language.	English* Français Español
Voicemail #	Set the speed dial voicemail number.	Voicemail # -
Clr voicemail	Turn off the voicemail indicators (see the note below).	Reset VM Icon?
Key tone	Set whether the handset beeps whenever a key is pressed.	Key tone:On* Key tone:Off
Home area code	Set the home area code so that the caller ID log stores only seven digits for local telephone numbers.	Home area code ---
Dial mode	Set the telephone to be touch-tone or pulse dialing.	Touch-tone* Pulse
Auto Answer	Set whether the handset answers a call automatically whenever you pick it from the telephone base when there is an incoming call.	On* Off

note

Use the **Clr voicemail** feature when the telephone indicates there is new voicemail but there is none. For example, when you have accessed your voicemail while away from home. The **Clr voicemail** feature only turns off the indicators; it does not delete your voicemail messages. As long as you have new voicemail messages, your telephone service provider continues to send the signal that turns on the indicators.

The following are some of the telephone features you may wish to set. Refer to **Telephone settings** in the online Complete user's manual for complete instructions on setting all telephone features.

Handset ringer volume

You can adjust the handset ringer volume level, or turn the ringer off.

1. Press **MENU** when the handset is not in use.
2. Scroll to **Ringers** and then press **SELECT** twice.
3. Press **▲** or **▼** to sample each volume level, then press **SELECT** to save.

note When the ringer volume is set to **Off**, the handset still rings when you press **📞/FIND HANDSET** at the bottom of the telephone base.

Quiet mode

You can turn on the quiet mode for a period of time. During this period, all tones (except paging tone) and call screening are muted. When you turn on the quiet mode, the answering system turns on automatically.

1. Press and hold **#** when the handset is not in use.
2. Use the dialing keys (**0-9**) to enter the duration (hour), then press **SELECT** to save.
- To turn off the quiet mode, press and hold **#** when the handset is not in use.

Set date and time

If you subscribe to caller ID service, the day, month and time are set automatically with each incoming call. You can also set the date and time manually.

1. Press **MENU** when the handset is not in use.
2. Scroll to **Set date/time** and then press **SELECT**.
3. Use the dialing keys (**0-9**) to enter the month (**MM**), date (**DD**) and year (**YY**). Then press **SELECT**.
4. Use the dialing keys (**0-9**) to enter the hour (**HH**) and minute (**MM**). Then press **▼** or **▲** to choose **AM** or **PM**.
5. Press **SELECT** to save.

Telephone operation

Make a call

Using the handset:

- Press **TALK** or **📞** and then dial the telephone number.

Using the telephone base:

- Press **📞** and then dial the telephone number.

Answer a call

Using the handset:

- Press **TALK**, **📞** or any dialing key.

-OR-

- Pick up the handset from the telephone base when **Auto Answer** is set to **On**.

Using the telephone base:

- Press **📞** or any dialing key.

End a call

Using the handset:

- Press **OFF** or put the handset back in the telephone base.

Using the telephone base:

- Press **📞**.

Handset speakerphone

- During a call, press **📞** to switch between speakerphone and normal handset use.

Volume

Using the handset:

- During a call, press **▲/VOLUME** or **▼/VOLUME** to adjust the listening volume.

Using the telephone base:

- During a call, tap **VOL+** or **VOL-** to adjust the listening volume.

Mute

The mute function allows you to hear the other party but the other party cannot hear you.

1. During a call, press **MUTE** on the handset or tap **MUTE** on the telephone base. The screen displays **Muted**.
2. Press **MUTE** on the handset or tap **MUTE** on the telephone base to resume the conversation. The screen displays **Microphone on** briefly.

Call waiting

When you subscribe to call waiting service from your telephone service provider, you hear an alert tone if there is an incoming call while you are already on a call.

- Press **FLASH** on the handset or tap **FLASH** on the telephone base to put the current call on hold and take the new call.
- Press **FLASH** on the handset or tap **FLASH** on the telephone base at any time to switch back and forth between calls.

Temporary ringer silencing

When the telephone is ringing, you can temporarily silence the ringer without disconnecting the call. The next call rings normally at the preset volume.

To silence the handset ringer:



- Press **OFF** or **MUTE** on the handset, then  displays and **Ringer muted** displays briefly.

To silence the telephone base ringer:

- Tap **MUTE** on the telephone base.

Temporary tone dialing

If you have pulse (rotary) service only, you can switch from pulse to touch-tone dialing temporarily during a call.

1. During a call, press  on the handset or  on the telephone base.
2. Use the dialing keys to enter the relevant number. The telephone sends touch-tone signals. It automatically returns to pulse dialing mode after you end the call.

Find handset

Use this feature to find the system handset.



To start paging:

- Press /**FIND HANDSET** at the bottom of the telephone base. The handset rings and displays **** Paging ****.

To end paging:

- Press /**FIND HANDSET** at the bottom of the telephone base.

-OR-

- Press  , **OFF** or any dialing key on the handset.

-OR-



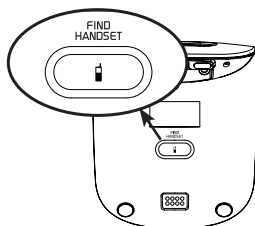

- Place the handset in the telephone base.



Redial list

The handset stores the last 10 telephone numbers dialed. When there are already 10 entries, the oldest entry is deleted to make room for the new entry.

To review and dial a number from the redial list on the handset:





1. Press **REDIAL** when the handset is not in use.
2. Press ,  or **REDIAL** repeatedly until the desired entry displays.
3. Press  or  to dial.

To delete a redial entry on the handset:

When the desired redial entry displays, press **DELETE**.

Join a call in progress



You can use the telephone base and the cordless handset, or two cordless handsets at a time on an outside call. You can buy additional expansion handsets (**LS6005/LS6005-13/LS6005-15/LS6005-16/LS6005-17**) for this telephone base. You can register up to five handsets to the telephone base.

- When a device is on a call, press  or  on another cordless handset, or press  on the telephone base to join the call.
- To exit the call, press **OFF** on the handset or place it back in the telephone base, or press  on the telephone base. The call continues until the other device hangs up.

Transfer a call

While on an outside call, you can transfer the call from one system device to another.

To transfer a call from the handset:

1. During a call, press **MENU**.
2. Scroll to  **Transfer**, then press **SELECT**.
 - When you have more than one handset, use the dialing keys to enter a destination device number (**7** for the telephone base, or **1 to 5** for **HANDSET 1** to **HANDSET 5**).
3. To answer the call on the telephone base, press .

-OR-



To answer the call on the handset, press   or any dialing key.

To transfer a call from the telephone base:

- Pick up the handset from the telephone base.



Intercom

Use the intercom feature for conversations between the telephone base and the cordless handset, or two cordless handsets. You can only use the handset to initiate an intercom call.

1. Press **INT** on the handset when not in use.
 - When you have more than one handset, use the dialing keys to enter a destination device number (**7** for the telephone base, or **1 to 5** for **HANDSET 1** to **HANDSET 5**).
2. To answer the intercom call at the telephone base, press  or any dialing key.
-OR-
To answer the intercom call on the handset, press  or any dialing key.
3. To end the intercom call, press **OFF** on the handset or place it back in the telephone base, or press  on the telephone base.

Answer an incoming call during an intercom call

If you receive an outside call during an intercom call, there is an alert tone.

- To answer the outside call, press  on the handset. The intercom call ends automatically.
- To end the intercom call without answering the outside call, press **OFF** on the handset, or press  on the telephone base. The intercom call ends and the telephone continues to ring.

Directory

The directory can store up to 50 directory entries which is shared by the handset and telephone base. You can only use the handset to add, edit or delete directory entries.

To add a directory entry using the handset:





1. Enter the number (up to 30 digits) when the phone is not in use then press **SELECT**. Then go to Step 3.
-OR-
When the phone is not in use, press **MENU** then scroll to  **Directory**, and then press **SELECT** twice.
2. Use the dialing keys to enter the number (up to 30 digits).
-OR-
Copy a number from the redial list by pressing **REDIAL** and then press **▼**, **▲** or **REDIAL** repeatedly to select a number. Press **SELECT** to copy the number.
3. Press **SELECT** to move on to enter the name.
4. Use the dialing keys to enter the name (up to 15 characters). Additional key presses show other characters of that particular key.
5. Press **SELECT** to save.

While entering names and numbers, you can:

- Press **DELETE** to backspace and erase a digit or character.
- Press and hold **DELETE** to erase the entire entry.
- Press **▼** or **▲** to move the cursor to the left or right.
- Press and hold **PAUSE** to insert a dialing pause (for entering numbers only).
- Press **0** to add a space (for entering names only).

To review and dial a number from the directory on the handset/telephone base:

Entries are sorted alphabetically.

1. Press  on the handset or tap  on the telephone base when the phone is not in use.
2. Scroll to browse through the directory.
3. When the desired entry appears, press  or  on the handset to dial.
-OR-
When the desired entry appears, press  on the telephone base to dial.

To edit a directory entry using the handset:

1. When the desired entry displays, press **SELECT**.
2. Use the dialing keys to edit the number, then press **SELECT**.
3. Use the dialing keys to edit the name, then press **SELECT** to confirm.



To delete a directory entry using the handset:

1. When the desired entry displays, press **DELETE**.
2. When the handset displays **Delete contact?**, press **SELECT**.

Speed dial

You can copy up to 9 directory entries into the speed dial locations (**0** and **2-9**) so that you can dial these numbers using fewer keys than usual. You can only use the handset to assign or delete speed dial entries.

To assign a speed dial entry using the handset:

1. Press **MENU** when the phone is not in use.
2. Scroll to  **Directory**, then press **SELECT**.
3. Scroll to  **Speed dial**, then press **SELECT**.
4. Scroll to a desired speed dial location, then press **SELECT**.
5. Scroll to a desired directory entry, then press **SELECT** to save.

To dial a speed dial entry on the handset/telephone base:

- Press and hold a dialing key (**0** or **2-9**) to dial the number stored in the corresponding location.

To delete a speed dial entry using the handset:

1. Press **MENU** when the phone is not in use.
2. Scroll to **◆Directory**, then press **SELECT**.
3. Scroll to **◆Speed dial**, then press **SELECT**.
4. Scroll to a desired speed dial location, then press **DELETE**. The handset displays **Clear SD #X?** Press **SELECT** to confirm.

Caller ID

This product supports caller ID services provided by most telephone service providers. Depending on your service subscription, you may see the caller's name, number, date and time of calls that are sent by your telephone service provider after the first or second ring.

Caller ID log

The caller ID log stores up to 50 entries. If you answer a call before the caller ID information displays, it will not be saved in the caller ID log.

- The handset and telephone base display **XX missed calls** when you have incoming calls that have not been answered.
- If you want to erase the missed call indicator, press and hold **CANCEL** on the idle handset.

To review and dial a number in the caller ID log on the handset/telephone base:

1. Press **CID** on the handset or tap **CID** on the telephone base when the phone is not in use.
2. Scroll to browse through the caller ID log. When the desired entry appears:
 - Press **#** on the handset or **#** on the telephone base repeatedly to show different dialing options.
 - Press **1** repeatedly if you need to add or remove 1 in front of the telephone number.
3. Press **TALK** or **📞** on the handset to dial.
-OR-
Press **📞** on the telephone base to dial.

To save a caller ID log entry to the directory using the handset:

1. When the desired caller ID log entry displays, press **SELECT**.
2. Use the dialing keys to modify the number, if necessary. Then press **SELECT**.
3. Use the dialing keys to modify the name, if necessary. Then press **SELECT**.

To delete a caller ID log entry with the handset:

- When the desired caller ID log entry displays, press **DELETE**.

To delete all caller ID log entries with the handset:

1. Press **MENU** when the phone is not in use.
2. Scroll to **◆Caller ID log** and then press **SELECT**.
3. Scroll to **◆Del all calls** then press **SELECT** twice.

About answering system and voicemail

Your telephone has separate indicators for two different types of voice messages: those left on the built-in answering system and those left at your telephone service provider's voicemail. Each alerts you to new messages differently.

- If **XX new messages** displays on the screens, there are messages recorded on the built-in answering system. It can record up to 59 messages, depending on the length of each message. Each message can be up to three minutes in length. The total recording time is approximately 11 minutes.
- If **📧** and **New voicemail** display on the screens, your telephone service provider is indicating that it has new voicemail for you. Contact your telephone service provider for more information on how to access your voicemail.

Answering system settings

Default settings are indicated by asterisks (*).

Settings menu	Description	Options
Call screening	Set whether you hear the callers while they are leaving messages to you.	Screening: On* Screening: Off
# of rings	Set the number of times the telephone rings before the answering system answers.	3*; 2; Toll saver; 6; 5; 4
Remote code	Set a two-digit security code to access the answering system remotely from any touch-tone telephone.	19*
Msg alert tone	Set whether the telephone beeps every 10 seconds to alert you of new messages.	Tone: Off* Tone: On
Recording time	Set the recording time for each incoming message.	3 minutes* 2 minutes 1 minute
Voice language	Set the language to be used for the voice prompts in your answering system.	English*; Français

Set number of rings

You can set the answering system to answer an incoming call after 2, 3, 4, 5 or 6 rings; or toll saver. If you choose toll saver, the answering system answers a call after 2 rings when you have new messages, or after 4 rings when you have no new messages.

1. Press **MENU** when the handset is not in use.
2. Scroll to **◆Answering sys** and then press **SELECT**.
3. Scroll to **◆Ans sys setup** and then press **SELECT**.
4. Scroll to **◆# of rings** and then press **SELECT**.
5. Press **▼** or **▲** to choose **◆6**, **◆5**, **◆4**, **◆3**, **◆2** or **◆Toll saver** and then press **SELECT** to save.

Record your own announcement

You can use the preset announcement to answer calls, or replace it with your own recorded announcement. The announcement can be up to 90 seconds in length.

1. Press **MENU** when the handset is not in use.
2. Scroll to **◆Answering Sys** then press **SELECT** twice.
3. The handset announces, *"To play, press 2. To record, press 7."* Then press **7** to record.
4. The handset announces, *"Record after the tone. Press 5 when you are done."* After the tone, speak towards the handset microphone.
5. Press **5** when done.

Answering system operation

Turn the answering system on or off

The answering system must be turned on to answer and record messages.

1. Press **MENU** when the handset is not in use.
2. Scroll to **◆Answering sys** and then press **SELECT**.
3. Scroll to **◆Answer on/off** and then press **SELECT**.
4. Press **▼** or **▲** to choose **◆Answer: On** or **◆Answer: Off** and then press **SELECT**.



Message playback at the telephone base

Tap **▶/■** when the phone is not in use.

Options during playback:

- Tap **VOL+** or **VOL-** to adjust the speaker volume.
- Press **2▶** to skip to the next message.
- Press **◀4** to repeat the playing message. Press **◀4** twice to listen to the previous message.
- Press **3x** to delete the playing message. The system advances to the next message.
- Tap **▶/■** to stop.

Call intercept

If you want to talk to the person whose message is being recorded, press  or  on the handset, or  on the telephone base.

Expand your telephone system

You can add new handsets (**LS6005/LS6005-13/LS6005-15/LS6005-16/LS6005-17**, purchased separately) to your telephone system. Your telephone base supports a maximum of five handsets.

For more details, refer to the user's manual that comes with your **LS6005/LS6005-13/LS6005-15/LS6005-16/LS6005-17** new handset.

Troubleshooting

If you have difficulty with your telephone, please try the suggestions below. For customer service, visit our website at www.vtechcanada.com or call 1 (800) 267-7377.

My telephone does not work at all.

- Make sure the battery is installed and charged correctly. For optimum daily performance, return the handset to the telephone base after use.
- Make sure the power adapter is securely plugged into an outlet not controlled by a wall switch.
- Make sure the telephone line cord is plugged firmly into the telephone base and the wall jack.
- Unplug the electrical power to the telephone base. Wait for approximately 15 seconds, then plug it back in. Allow up to one minute for the cordless handset and telephone base to synchronize.
- Charge the battery in the handset for up to 11 hours.
- If the battery is completely depleted, charge the handset for at least 30 minutes before use.
- Remove the battery and then install it again. If that still does not work, it may be necessary to purchase a new battery.
- Disconnect the telephone base from the telephone wall jack and plug in a working telephone. If the other telephone does not work, the problem is probably in the wiring or the telephone service. Contact your telephone service provider.

The display shows No line. I cannot get a dial tone.

- Try all the suggestions above.
- If the previous suggestions do not work, disconnect the telephone base from the telephone jack and connect to a different phone. If there is no dial tone on that phone either, the problem is in your wiring or telephone service. Contact your telephone service provider.
- Your line cord may be defective. Try installing a new line cord.
- If you have changed your telephone service to digital service from a cable company or a VoIP service provider, the telephone line may need to be rewired to allow all existing telephone jacks to work. Contact your service provider for more information.

I cannot dial out.

- Try all the above suggestions.
- Make sure there is a dial tone before dialing. It is normal if the handset takes a second or two to synchronize with the telephone base before producing a dial tone. Wait an extra second before dialing.
- If other telephones in your home are having the same problem, the problem is in the wiring or telephone service. Contact your telephone service provider (charges may apply).
- Eliminate any background noise. Mute the cordless handset before dialing, or dial from another room in your home with less background noise.

The display shows To register HS... and ...see manual alternately. The handset does not work at all.

- The handset is deregistered from the telephone base. To register it back:
 1. At the bottom of the telephone base, **press and hold**  **FIND HANDSET** for about four seconds until it shows **Registering...**
 2. On the cordless handset, press **#** then it shows **Registering...** Both the telephone base and cordless handset show **Registered** and you hear a beep when the registration process completes. The registration process takes about 60 seconds to complete.

If registration fails, the handset displays **Failed**. Try the registration process again.

The answering system does not answer after the correct number of rings.

- Make sure the answering system is on. When the answering system is on, **ANS ON** should display on the handset and the telephone base.
- If toll saver is selected, the number of rings changes to two when there are new messages waiting.
- If the memory is full or if the answering system is off, the answering system answers after 10 rings.
- In some cases, the answering system is affected by the ringing system used by your telephone service provider.
- If you subscribe to voicemail service, change the number of rings so that your answering system answers before your voicemail answers. To determine how many rings activate your voicemail, please contact your telephone service provider.
- If there is a fax machine connected to the same telephone line, try disconnecting the fax machine. If that solves the problem, consult your fax machine documentation for information on compatibility with answering systems.

The answering system does not record messages.

- Make sure the answering system is on.
- When the answering machine memory is full, it does not record new messages until some old messages are deleted.
- If you subscribe to voicemail service, change the number of rings so that your answering system answers before your voicemail answers. To determine how many rings activate your voicemail, please contact your telephone service provider.
- If there is a fax machine connected to the same telephone line, try disconnecting the fax machine. If that solves the problem, consult your fax machine documentation for information on compatibility with answering systems.

The messages on the answering system are incomplete.

- If a caller leaves a very long message, part of it may be lost when the answering system disconnects the call after the preset recording time.
- If the memory on the answering system becomes full during a message, the answering system stops recording and disconnects the call.
- If the caller's voice is very soft, the answering system may stop recording and disconnect the call.

I accidentally set my LCD language to Spanish or French, and I don't know how to change it back to English.

- While the handset is in idle mode, press **MENU** and then enter *** 364 #**.
- While the handset is on a call, press **MENU** and then enter *** 364 #**. Then press **OFF** to exit the menu.

Common cure for electronic equipment.

- If the telephone is not responding normally, put the cordless handset in the telephone base. If it does not respond, try the following (in the order listed):
 1. Disconnect the power to the telephone base.
 2. Disconnect the battery on the cordless handset.
 3. Wait a few minutes before connecting power to the telephone base.
 4. Install the battery again and place the cordless handset in the telephone base.
 5. Wait for the cordless handset to synchronize with the telephone base. Allow up to one minute for this to take place.

Important safety instructions

When using your telephone equipment, basic safety precautions should always be followed to reduce the risk of fire, electric shock and injury, including the following:

1. Read and understand all instructions.
2. Follow all warnings and instructions marked on the product.
3. Unplug this product from the wall outlet before cleaning. Do not use liquid or aerosol cleaners. Use a damp cloth for cleaning.
4. Do not use this product near water such as near a bath tub, wash bowl, kitchen sink, laundry tub or a swimming pool, or in a wet basement or shower.
5. Do not place this product on an unstable table, shelf, stand or other unstable surfaces.
6. Avoid placing the telephone system in places with extreme temperature, direct sunlight, or other electrical devices. Protect your phone from moisture, dust, corrosive liquids and fumes.
7. Slots and openings in the back or bottom of the telephone base and handset are provided for ventilation. To protect them from overheating, these openings must not be blocked by placing the product on a soft surface such as a bed, sofa or rug. This product should never be placed near or over a radiator or heat register. This product should not be placed in any area where proper ventilation is not provided.
8. This product should be operated only from the type of power source indicated on the marking label. If you are not sure of the type of power supply in your home or office, consult your dealer or local power company.
9. Do not allow anything to rest on the power cord. Do not install this product where the cord may be walked on.
10. Never push objects of any kind into this product through the slots in the telephone base or handset because they may touch dangerous voltage points or create a short circuit. Never spill liquid of any kind on the product.
11. To reduce the risk of electric shock, do not disassemble this product, but take it to an authorized service facility. Opening or removing parts of the telephone base or handset other than specified access doors may expose you to dangerous voltages or other risks. Incorrect reassembling can cause electric shock when the product is subsequently used.
12. Do not overload wall outlets and extension cords.
13. Unplug this product from the wall outlet and refer servicing to an authorized service facility under the following conditions:
 - When the power supply cord or plug is damaged or frayed.
 - If liquid has been spilled onto the product.
 - If the product has been exposed to rain or water.
 - If the product does not operate normally by following the operating instructions. Adjust only those controls that are covered by the operation instructions. Improper adjustment of other controls may result in damage and often requires extensive work by an authorized technician to restore the product to normal operation.
 - If the product has been dropped and the telephone base and/or handset has been damaged.
 - If the product exhibits a distinct change in performance.
14. Avoid using a telephone (other than cordless) during an electrical storm. There is a remote risk of electric shock from lightning.
15. Do not use the telephone to report a gas leak in the vicinity of the leak. Under certain circumstances, a spark may be created when the adapter is plugged into the power outlet, or when the handset is replaced in its cradle. This is a common event associated with the closing of any electrical circuit. The user should not plug the phone into a power outlet, and should not put a charged handset into the cradle, if the phone is located in an environment containing concentrations of flammable or flame-supporting gases, unless there is adequate ventilation. A spark in such an environment could create a fire or explosion. Such environments might include: medical use of oxygen without adequate ventilation; industrial gases (cleaning solvents; gasoline vapors; etc.); a leak of natural gas; etc.
16. Only put the handset of your telephone next to your ear when it is in normal talk mode.
17. The power adapter is intended to be correctly oriented in a vertical or floor mount position. The prongs are not designed to hold the plug in place if it is plugged into a ceiling, under-the-table or cabinet outlet.

SAVE THESE INSTRUCTIONS

Battery

- **CAUTION:** Use Only Supplied Battery.
- Do not dispose of the battery in a fire. Check with local waste management codes for special disposal instructions.
- Do not open or mutilate the battery. Released electrolyte is corrosive and may cause burns or injury to the eyes or skin. The electrolyte may be toxic if swallowed.
- Exercise care in handling batteries in order not to create a short circuit with conductive materials.
- Charge the battery provided with this product only in accordance with the instructions and limitations specified in this manual.

Precautions for users of implanted cardiac pacemakers

Cardiac pacemakers (applies only to digital cordless telephones):

Wireless Technology Research, LLC (WTR), an independent research entity, led a multidisciplinary evaluation of the interference between portable wireless telephones and implanted cardiac pacemakers. Supported by the U.S. Food and Drug Administration, WTR recommends to physicians that:

Pacemaker patients

- Should keep wireless telephones at least six inches from the pacemaker.
- Should NOT place wireless telephones directly over the pacemaker, such as in a breast pocket, when it is turned ON.
- Should use the wireless telephone at the ear opposite the pacemaker.

WTR's evaluation did not identify any risk to bystanders with pacemakers from other persons using wireless telephones.

Operating range

This cordless telephone operates with the maximum power allowed by the Federal Communications Commission (FCC). Even so, this handset and telephone base can communicate over only a certain distance - which can vary with the locations of the telephone base and handset, the weather, and the layout of your home or office.

When the handset is out of range, the handset displays **Out of range or no pwr at base**.

If there is a call while the handset is out of range, it may not ring, or if it does ring, the call may not connect well when you press **CALL**. Move closer to the telephone base, then press **CALL** to answer the call.

If the handset moves out of range during a telephone conversation, there may be interference. To improve reception, move closer to the telephone base.

ECO mode

This power conserving technology reduces power consumption for optimal battery performance. The ECO mode activates automatically whenever the handset is synchronized with the telephone base.

Maintenance

Taking care of your telephone

Your cordless telephone contains sophisticated electronic parts, so it must be treated with care.

Avoid rough treatment

Place the handset down gently. Save the original packing materials to protect your telephone if you ever need to ship it.

Avoid water

Your telephone can be damaged if it gets wet. Do not use the handset outdoors in the rain, or handle it with wet hands. Do not install the telephone base near a sink, bathtub or shower.

Electrical storms

Electrical storms can sometimes cause power surges harmful to electronic equipment. For your own safety, take caution when using electrical appliances during storms.

Cleaning your telephone

Your telephone has a durable plastic casing that should retain its luster for many years. Clean it only with a dry non-abrasive cloth. Do not use dampened cloth or cleaning solvents of any kind.

Remember that electrical appliances can cause serious injury if used when you are wet or standing in water. If the telephone base should fall into water, **DO NOT RETRIEVE IT UNTIL YOU UNPLUG THE POWER CORD AND TELEPHONE LINE CORD FROM THE WALL**. Then remove the telephone by the unplugged cords.

About cordless telephones

- **Privacy:** The same features that make a cordless telephone convenient create some limitations. Telephone calls are transmitted between the telephone base and the cordless handset by radio waves, so there is a possibility that the cordless telephone conversations could be intercepted by radio receiving equipment within range of the cordless handset. For this reason, you should not think of cordless telephone conversations as being as private as those on corded telephones.
- **Electrical power:** The telephone base of this cordless telephone must be connected to a working electrical outlet. The electrical outlet should not be controlled by a wall switch. Calls cannot be made from the cordless handset if the telephone base is unplugged, switched off or if the electrical power is interrupted.
- **Potential TV interference:** Some cordless telephones operate at frequencies that may cause interference to televisions and VCRs. To minimize or prevent such interference, do not place the telephone base of the cordless telephone near or on top of a TV or VCR. If interference is experienced, moving the cordless telephone farther away from the TV or VCR often reduces or eliminates the interference.
- **Rechargeable batteries:** Exercise care in handling batteries in order not to create a short circuit with conducting material such as rings, bracelets and keys. The battery or conductor may overheat and cause harm. Observe proper polarity between the battery and the battery charger.
- **Nickel-metal hydride rechargeable batteries:** Dispose of these batteries in a safe manner. Do not burn or puncture the battery. Like other batteries of this type, if burned or punctured, they could release caustic material which could cause injury.

The RBRC® seal

The RBRC® seal on the nickel-metal hydride battery indicates that VTech Communications, Inc. is voluntarily participating in an industry program to collect and recycle these batteries at the end of their useful lives, when taken out of service within the United States and Canada.

The RBRC® program provides a convenient alternative to placing used nickel-metal hydride batteries into the trash or municipal waste, which may be illegal in your area.

VTech's participation in RBRC® makes it easy for you to drop off the spent battery at local retailers participating in the RBRC® program or at authorized VTech product service centers. Please call **1 (800) 8 BATTERY®** for information on Ni-MH battery recycling and disposal bans/restrictions in your area. VTech's involvement in this program is part of its commitment to protecting our environment and conserving natural resources.

RBRC® and 1 (800) 8 BATTERY® are registered trademarks of Rechargeable Battery Recycling Corporation.



FCC, ACTA and IC regulations

FCC Part 15

This equipment has been tested and found to comply with the requirements for a Class B digital device under Part 15 of the Federal Communications Commission (FCC) rules. These requirements are intended to provide reasonable protection against harmful interference in a residential installation. This equipment generates, uses and can radiate radio frequency energy and, if not installed and used in accordance with the instructions, may cause harmful interference to radio communications. However, there is no guarantee that interference will not occur in a particular installation. If this equipment does cause harmful interference to radio or television reception, which can be determined by turning the equipment off and on, the user is encouraged to try to correct the interference by one or more of the following measures:

- Reorient or relocate the receiving antenna.
- Increase the separation between the equipment and receiver.
- Connect the equipment into an outlet on a circuit different from that to which the receiver is connected.
- Consult the dealer or an experienced radio/TV technician for help.

Changes or modifications to this equipment not expressly approved by the party responsible for compliance could void the user's authority to operate the equipment.

This device complies with Part 15 of the FCC rules. Operation is subject to the following two conditions: (1) this device may not cause harmful interference, and (2) this device must accept any interference received, including interference that may cause undesired operation. Privacy of communications may not be ensured when using this telephone.

To ensure safety of users, the FCC has established criteria for the amount of radio frequency energy that can be safely absorbed by a user or bystander according to the intended usage of the product. This product has been tested and found to comply with the FCC criteria. The handset may be safely held against the ear of the user. The telephone base shall be installed and used such that parts of the user's body other than the hands are maintained at a distance of approximately 20 cm (8 inches) or more.

This Class B digital apparatus complies with Canadian requirement:

CAN ICES-3 (B)/NMB-3(B).

FCC Part 68 and ACTA

This equipment complies with Part 68 of the FCC rules and with technical requirements adopted by the Administrative Council for Terminal Attachments (ACTA). The label on the back or bottom of this equipment contains, among other things, a product identifier in the format US:AAAEQ##TXXXX. This identifier must be provided to your telephone service provider upon request.

The plug and jack used to connect this equipment to premises wiring and the telephone network must comply with applicable Part 68 rules and technical requirements adopted by ACTA. A compliant telephone cord and modular plug is provided with this product. It is designed to be connected to a compatible modular jack that is also compliant. An RJ11 jack should normally be used for connecting to a single line and an RJ14 jack for two lines. See the installation instructions in the user's manual.

The Ringer Equivalence Number (REN) is used to determine how many devices you may connect to your telephone line and still have them ring when you are called. The REN for this product is encoded as the 6th and 7th characters following the US: in the product identifier (e.g., if ## is 03, the REN is 0.3). In most, but not all areas, the sum of all RENs should be five (5.0) or less. For more information, please contact your telephone service provider.

This equipment may not be used with Party Lines. If you have specially wired alarm dialing equipment connected to your telephone line, ensure the connection of this equipment does not disable your alarm equipment. If you have questions about what will disable alarm equipment, consult your telephone service provider or a qualified installer.

If this equipment is malfunctioning, it must be unplugged from the modular jack until the problem has been corrected. Repairs to this telephone equipment can only be made by the manufacturer or its authorized agents. For repair procedures, follow the instructions outlined under the **Limited warranty**.

If this equipment is causing harm to the telephone network, the telephone service provider may temporarily discontinue your telephone service. The telephone service provider is required to notify you before interrupting service. If advance notice is not practical, you will be notified as soon as possible. You will be given the opportunity to correct the problem and the telephone service provider is required to inform you of your right to file a complaint with the FCC. Your telephone service provider may make changes in its facilities, equipment, operation, or procedures that could affect the proper functioning of this product. The telephone service provider is required to notify you if such changes are planned.

If this product is equipped with a corded or cordless handset, it is hearing aid compatible.

If this product has memory dialing locations, you may choose to store emergency telephone numbers (e.g., police, fire, medical) in these locations. If you do store or test emergency numbers, please:

Remain on the line and briefly explain the reason for the call before hanging up.

Perform such activities in off-peak hours, such as early morning or late evening.

Industry Canada

This device complies with Industry Canada licence-exempt RSS standard(s).

Operation is subject to the following two conditions: (1) this device may not cause harmful interference, and (2) this device must accept any interference received, including interference that may cause undesired operation.

Privacy of communications may not be ensured when using this telephone.

The term "IC:" before the certification/registration number only signifies that the Industry Canada technical specifications were met.

The Ringer Equivalence Number (REN) for this terminal equipment is 1.0. The REN is an indication of the maximum number of devices allowed to be connected to a telephone interface. The termination on an interface may consist of any combination of devices subject only to the requirement that the sum of the RENs of all the devices does not exceed five.

This product meets the applicable Industry Canada technical specifications.

Limited warranty

What does this limited warranty cover?

The manufacturer of this VTech Product warrants to the holder of a valid proof of purchase ("Consumer" or "you") that the Product and all accessories provided in the sales package ("Product") are free from defects in material and workmanship, pursuant to the following terms and conditions, when installed and used normally and in accordance with the Product operating instructions. This limited warranty extends only to the Consumer for Products purchased and used in the United States of America and Canada.

What will VTech do if the Product is not free from defects in materials and workmanship during the limited warranty period ("Materially Defective Product")?

During the limited warranty period, VTech's authorized service representative will repair or replace at VTech's option, without charge, a Materially Defective Product. If we repair the Product, we may use new or refurbished replacement parts. If we choose to replace the Product, we may replace it with a new or refurbished Product of the same or similar design. We will retain defective parts, modules, or equipment. Repair or replacement of the Product, at VTech's option, is your exclusive remedy. VTech will return the repaired or replacement Products to you in working condition. You should expect the repair or replacement to take approximately 30 days.

How long is the limited warranty period?

The limited warranty period for the Product extends for ONE (1) YEAR from the date of purchase. If VTech repairs or replaces a Materially Defective Product under the terms of this limited warranty, this limited warranty also applies to the repaired or replacement Product for a period of either (a) 90 days from the date the repaired or replacement Product is shipped to you or (b) the time remaining on the original one-year warranty; whichever is longer.

What is not covered by this limited warranty?

This limited warranty does not cover:

1. Product that has been subjected to misuse, accident, shipping or other physical damage, improper installation, abnormal operation or handling, neglect, inundation, fire, water or other liquid intrusion; or
2. Product that has been damaged due to repair, alteration or modification by anyone other than an authorized service representative of VTech; or
3. Product to the extent that the problem experienced is caused by signal conditions, network reliability, or cable or antenna systems; or
4. Product to the extent that the problem is caused by use with non-VTech accessories; or
5. Product whose warranty/quality stickers, product serial number plates or electronic serial numbers have been removed, altered or rendered illegible; or
6. Product purchased, used, serviced, or shipped for repair from outside the United States of America or Canada, or used for commercial or institutional purposes (including but not limited to Products used for rental purposes); or
7. Product returned without a valid proof of purchase (see item 2 below); or
8. Charges for installation or set up, adjustment of customer controls, and installation or repair of systems outside the unit.

How do you get warranty service?

To obtain warranty service in Canada, please visit our website at www.vtechcanada.com or call 1 (800) 267-7377.

NOTE: Before calling for service, please review the user's manual - a check of the Product's controls and features may save you a service call.

Except as provided by applicable law, you assume the risk of loss or damage during transit and transportation and are responsible for delivery or handling charges incurred in the transport of the Product(s) to the service location. VTech will return repaired or replaced Product under this limited warranty. Transportation, delivery or handling charges are prepaid. VTech assumes no risk for damage or loss of the Product in transit. If the Product failure is not covered by this limited warranty, or proof of purchase does not meet the terms of this limited warranty, VTech will notify you and will request that you authorize the cost of repair prior to any further repair activity. You must pay for the cost of repair and return shipping costs for the repair of Products that are not covered by this limited warranty.

What must you return with the Product to get warranty service?

1. Return the entire original package and contents including the Product to the VTech service location along with a description of the malfunction or difficulty; and
2. Include a "valid proof of purchase" (sales receipt) identifying the Product purchased (Product model) and the date of purchase or receipt; and
3. Provide your name, complete and correct mailing address, and telephone number.

Other limitations

This warranty is the complete and exclusive agreement between you and VTech. It supersedes all other written or oral communications related to this Product. VTech provides no other warranties for this Product. The warranty exclusively describes all of VTech's responsibilities regarding the Product. There are no other express warranties. No one is authorized to make modifications to this limited warranty and you should not rely on any such modification.

State/Provincial Law Rights: This warranty gives you specific legal rights, and you may also have other rights, which vary from state to state or province to province.

Limitations: Implied warranties, including those of fitness for a particular purpose and merchantability (an unwritten warranty that the Product is fit for ordinary use) are limited to one year from the date of purchase. Some states/provinces do not allow limitations on how long an implied warranty lasts, so the above limitation may not apply to you. In no event shall VTech be liable for any indirect, special, incidental, consequential, or similar damages (including, but not limited to lost profits or revenue, inability to use the Product or other associated equipment, the cost of substitute equipment, and claims by third parties) resulting from the use of this Product. Some states/provinces do not allow the exclusion or limitation of incidental or consequential damages, so the above limitation or exclusion may not apply to you.

Please retain your original sales receipt as proof of purchase.

Technical specifications

Frequency control	Crystal controlled PLL synthesizer
Transmit frequency	Handset: 1921.536-1928.448 MHz Telephone base: 1921.536-1928.448 MHz
Channels	5
Nominal effective range	Maximum power allowed by FCC and IC. Actual operating range may vary according to environmental conditions at the time of use.
Power requirements	Handset: 2.4V Ni-MH battery Telephone base: 6V DC @ 450mA
Memory	Directory: 50 memory locations; up to 30 digits and 15 characters Caller ID log: 50 memory locations; up to 24 digits and 15 characters



Designed to fit your home.
And your life.

VTech Technologies Canada Ltd.
A member of THE VTECH GROUP OF COMPANIES.
VTech is a registered trademark of VTech Holdings Limited.
Specifications are subject to change without notice.
© 2015 VTech Technologies Canada Ltd.
All rights reserved. 01/15. LS6195-X_CA_ACIB_V5
Document order number: 91-006539-030-100

