

LS

6331

6331-2

6331-3

6331-4

6331-5



Scan the QR code to go and
subscribe our tutorial channel

vtech[®]

User's manual

Congratulations

on purchasing your new VTech product. Before using this telephone, please read Important safety instructions.

This manual has all the feature operations and troubleshooting necessary to install and operate your new VTech telephone. Please review this manual thoroughly to ensure proper installation and operation of this innovative and feature rich VTech product.

For support, shopping, and everything new at VTech, visit our website at www.vtechphones.com. In Canada, please visit phones.vtechcanada.com.



Telephones identified with this logo have reduced noise and interference when used with most T-coil equipped hearing aids and cochlear implants. The TIA-1083 Compliant Logo is a trademark of the Telecommunications Industry Association. Used under license.



The ENERGY STAR® program (www.energystar.gov) recognizes and encourages the use of products that save energy and help protect our environment. We are proud to mark this product with the ENERGY STAR® label indicating it meets the latest energy efficiency guidelines.

Important safety instructions



When using your telephone equipment, basic safety precautions should always be followed to reduce the risk of fire, electric shock and injury, including the following:

1. Read and understand all instructions.
2. Follow all warnings and instructions marked on the product.
3. Use only with UL listed Bluetooth devices.
4. Unplug this product from the wall outlet before cleaning. Do not use liquid or aerosol cleaners. Use a damp cloth for cleaning.
5. **CAUTION:** Do not install the telephone base at a height above 2 meters.
6. Do not use this product near water such as near a bath tub, wash bowl, kitchen sink, laundry tub or a swimming pool, or in a wet basement or shower.
7. Do not place this product on an unstable table, shelf, stand or other unstable surfaces.
8. Avoid placing the telephone system in places with extreme temperature, direct sunlight, or other electrical devices. Protect your phone from moisture, dust, corrosive liquids and fumes.
9. Slots and openings in the back or bottom of the telephone base and handset are provided for ventilation. To protect them from overheating, these openings must not be blocked by placing the product on a soft surface such as a bed, sofa or rug. This product should never be placed near or over a radiator or heat register. This product should not be placed in any area where proper ventilation is not provided.
10. This product should be operated only from the type of power source indicated on the marking label. If you are not sure of the type of power supply in your home or office, consult your dealer or local power company.
11. Do not allow anything to rest on the power cord. Do not install this product where the cord may be walked on.
12. Never push objects of any kind into this product through the slots in the telephone base or handset because they may touch dangerous voltage points or create a short circuit. Never spill liquid of any kind on the product.
13. To reduce the risk of electric shock, do not disassemble this product, but take it to an authorized service facility. Opening or removing parts of the telephone base or handset other

than specified access doors may expose you to dangerous voltages or other risks. Incorrect reassembling can cause electric shock when the product is subsequently used.

14. Do not overload wall outlets and extension cords.
15. Unplug this product from the wall outlet and refer servicing to an authorized service facility under the following conditions:
 - When the power supply cord or plug is damaged or frayed.
 - If liquid has been spilled onto the product.
 - If the product has been exposed to rain or water.
 - If the product does not operate normally by following the operating instructions. Adjust only those controls that are covered by the operation instructions. Improper adjustment of other controls may result in damage and often requires extensive work by an authorized technician to restore the product to normal operation.
 - If the product has been dropped and the telephone base and/or handset has been damaged.
 - If the product exhibits a distinct change in performance.
16. Avoid using a telephone (other than cordless) during an electrical storm. There is a remote risk of electric shock from lightning.
17. Do not use the telephone to report a gas leak in the vicinity of the leak. Under certain circumstances, a spark may be created when the adapter is plugged into the power outlet, or when the handset is replaced in its cradle. This is a common event associated with the closing of any electrical circuit. The user should not plug the phone into a power outlet, and should not put a charged handset into the cradle, if the phone is located in an environment containing concentrations of flammable or flame-supporting gases, unless there is adequate ventilation. A spark in such an environment could create a fire or explosion. Such environments might include: medical use of oxygen without adequate ventilation; industrial gases (cleaning solvents; gasoline vapors; etc.); a leak of natural gas; etc.
18. Only put the handset of your telephone next to your ear when it is in normal talk mode.
19. The power adapter is intended to be correctly oriented in a vertical or floor mount position. The

prongs are not designed to hold the plug in place if it is plugged into a ceiling, under-the-table or cabinet outlet.

20. For pluggable equipment, the socket outlet shall be installed near the equipment and shall be easily accessible.
21.   **CAUTION:** Use only the batteries indicated in this manual. There may be a risk of explosion if a wrong type of battery is used for the handset. Use only the supplied rechargeable batteries or replacement batteries (BT162342/ BT262342) for the handset. Do not dispose of batteries in a fire. They may explode.
 - Do not use the battery in following conditions:
 - » High or low extreme temperature during use, storage or transportation.
 - » Replacement of a battery with an incorrect type that can defeat a safeguard.
 - » Disposal of a battery into fire or a hot oven, or mechanically crushing or cutting of a battery, that can result in an explosion.
 - » Leaving a battery in an extremely high temperature surrounding environment that can result in an explosion or the leakage of flammable liquid or gas.
 - » A battery subjected to extremely low air pressure that can result in an explosion or the leakage of flammable liquid or gas.
22. Use only the adapter included with this product. Incorrect adapter polarity or voltage can seriously damage the product.
23. The applied nameplate is located at the bottom or near of the product.

SAVE THESE INSTRUCTIONS

Battery

- Use only the batteries provided or equivalent. To order a replacement, visit our website at www.vtechphones.com or call 1 (800) 595-9511. In Canada, go to phones.vtechcanada.com or call 1 (800) 267-7377.
- Do not dispose of the battery in a fire. Check with local waste management codes for special disposal instructions.
- Do not open or mutilate the battery. Released electrolyte is corrosive and may cause burns or injury to the eyes or skin. The electrolyte may be toxic if swallowed.
- Exercise care in handling batteries in order not to create a short circuit with conductive materials.

- Charge the battery provided with this product only in accordance with the instructions and limitations specified in this manual.

Precautions for users of implanted cardiac pacemakers

Cardiac pacemakers (applies only to digital cordless telephones):

Wireless Technology Research, LLC (WTR), an independent research entity, led a multidisciplinary evaluation of the interference between portable wireless telephones and implanted cardiac pacemakers. Supported by the U.S. Food and Drug Administration, WTR recommends to physicians that:

Pacemaker patients

- Should keep wireless telephones at least six inches from the pacemaker.
- Should NOT place wireless telephones directly over the pacemaker, such as in a breast pocket, when it is turned ON.
- Should use the wireless telephone at the ear opposite the pacemaker.

WTR's evaluation did not identify any risk to bystanders with pacemakers from other persons using wireless telephones.

About cordless telephones

- **Privacy:** The same features that make a cordless telephone convenient create some limitations. Telephone calls are transmitted between the telephone base and the cordless handset by radio waves, so there is a possibility that the cordless telephone conversations could be intercepted by radio receiving equipment within range of the cordless handset. For this reason, you should not think of cordless telephone conversations as being as private as those on corded telephones.
- **Electrical power:** The telephone base of this cordless telephone must be connected to a working electrical outlet. The electrical outlet should not be controlled by a wall switch. Calls cannot be made from the cordless handset if the telephone base is unplugged, switched off or if the electrical power is interrupted.
- **Potential TV interference:** Some cordless telephones operate at frequencies that may cause interference to televisions and VCRs. To minimize or prevent such interference, do not place the telephone base of the cordless telephone near or on top of a TV or VCR. If interference is

experienced, moving the cordless telephone farther away from the TV or VCR often reduces or eliminates the interference.

- **Rechargeable batteries:** Exercise care in handling batteries in order not to create a short circuit with conducting material such as rings, bracelets and keys. The battery or conductor may overheat and cause harm. Observe proper polarity between the battery and the battery charger.
- **Nickel-metal hydride rechargeable batteries:** Dispose of these batteries in a safe manner. Do not burn or puncture the battery. Like other batteries of this type, if burned or punctured, they could release caustic material which could cause injury.

ECO mode

This power conserving technology reduces power consumption for optimal battery performance. The ECO mode activities automatically whenever the handset is synchronized with the telephone base.

For C-UL compliance only

Mesures de sécurité importantes



Afin de réduire les risques d'incendie, de blessures corporelles ou d'électrocution, suivez toujours ces mesures préventives de base lorsque vous utilisez votre téléphone :

1. Lisez et comprenez bien toutes les instructions.
2. Observez toutes les instructions et mises en garde inscrites sur l'appareil.
3. N'utiliser qu'avec des dispositifs Bluetooth homologués par UL.
4. Débranchez ce téléphone de la prise murale avant de le nettoyer. N'utilisez pas de nettoyeurs liquides ni en aérosol. N'utilisez qu'un chiffon doux et légèrement humecté.
5. **ATTENTION:** Ne pas installer le socle téléphonique à une hauteur supérieure à 2 mètres.
6. N'utilisez pas ce produit près de l'eau, tel que près d'un bain, d'un lavabo, d'un évier de cuisine, d'un bac de lavage ou d'une piscine, ou dans un sous-sol humide ou sous la douche.
7. Ne déposez pas ce téléphone sur un chariot, support ou table chancelants. L'appareil pourrait tomber et être sérieusement endommagé.
8. Évitez d'installer le système téléphonique dans les endroits soumis à une température extrême, à la lumière directe du soleil ou à proximité

immédiate d'autres appareils électriques ou électroniques. Protégez votre téléphone contre les sources d'humidité, la poussière, les vapeurs et les liquides corrosifs.

9. Le boîtier de l'appareil est doté de fentes et d'ouvertures d'aération situées à l'arrière ou en dessous. Afin d'empêcher la surchauffe, ces ouvertures ne doivent pas être obstruées en plaçant l'appareil sur un lit, divan, tapis ou autre surface similaires. Ne placez pas cet appareil proximité d'un élément de chauffage ni d'une plinthe électrique. De plus, ne l'installez pas dans une unité murale ou un cabinet fermé qui ne possède pas d'aération adéquate.
10. Ne faites fonctionner cet appareil qu'avec le type d'alimentation indiqué sur les étiquettes de l'appareil. Si vous ne connaissez pas le voltage de votre maison, consultez votre marchand ou votre fournisseur d'électricité.
11. Ne déposez rien sur le cordon d'alimentation. Installez cet appareil dans un endroit sécuritaire, là où personne ne pourra trébucher sur la ligne d'alimentation ni le cordon téléphonique modulaire.
12. N'insérez jamais d'objets à travers les fentes et ouvertures de cet appareil, car ils pourraient toucher à des points de tension dangereux ou court-circuiter des pièces, ce qui constituerait un risque d'incendie ou d'électrocution. N'échappez pas de liquides dans l'appareil.
13. Afin de réduire les risques d'électrocution, ne démontez pas l'appareil, mais apportez-le plutôt à un centre de service qualifié s'il doit être réparé. En enlevant le couvercle, vous vous exposez à des tensions dangereuses ou autres dangers similaires. Un remontage inadéquat peut être à l'origine d'une électrocution lors d'une utilisation ultérieure de l'appareil. Débranchez l'appareil avant de procéder au nettoyage. Utilisez un chiffon humide et doux.
14. Ne surchargez pas les prises de courant et les rallonges.
15. Débranchez cet appareil de la prise de courant et communiquez avec le département de service à la clientèle de VTech dans les cas suivants:
 - Lorsque le cordon d'alimentation est endommagé ou écorché.
 - Si du liquide a été échappé dans l'appareil.
 - Si l'appareil a été exposé une source d'humidité telle que la pluie ou l'eau.
 - Si le produit ne fonctionne pas normalement

en respectant les instructions de fonctionnement. Réglez uniquement les commandes indiquées dans les instructions de fonctionnement. Les réglages incorrects des autres commandes pourraient provoquer un dommage qui pourrait exiger un travail exhaustif de la part d'un technicien autorisé afin de rétablir le fonctionnement normal de l'appareil.

- Si le produit a été échappé et que le socle et/ou le combiné a été endommagé.
 - Si le produit affiche une nette diminution de sa performance.
16. Évitez d'utiliser un téléphone (autre qu'un sans fil) pendant un orage. Les éclairs peuvent être à l'origine d'une électrocution.
 17. N'utilisez pas le téléphone pour rapporter une fuite de gaz à proximité de la fuite. En certaines circonstances, une flammèche pourrait être provoquée lorsque l'adaptateur est branché à une prise de courant, ou lorsque le combiné est déposé sur le socle. Ceci est un événement commun associé à la fermeture d'un circuit électrique. L'utilisateur ne devrait pas brancher le téléphone à une prise de courant, et ne devrait pas déposer le combiné chargé sur le socle, si le téléphone se trouve à proximité d'un endroit comportant des concentrations de gaz inflammables, moins que la ventilation soit adéquate. Une flammèche dans un tel endroit pourrait provoquer un incendie ou une explosion. De tels environnements peuvent comprendre: des endroits où l'on utilise de l'oxygène médical sans ventilation adéquate; des gaz industriels (dissolvants de nettoyage, des vapeurs d'essence, etc.); une fuite de gaz naturel, etc.
 18. Ne placez que le combiné de votre téléphone près de votre oreille lorsqu'en mode de conversation.
 19. Ces adaptateurs ont été conçus pour être orientés en position verticale ou montés au sol. Les broches ne sont pas conçues pour maintenir l'adaptateur en place si celui-ci est branché dans une prise au plafond ou sous une table/ armoire.
 20. Pour le MATÉRIEL RACCORDE PAR PRISE DE COURANT, le socle de prise de courant doit être installé à proximité du matériel et doit être aisément accessible.
 21.   **MISE EN GARDE:** Il peut y avoir un risque d'explosion si vous utilisez le mauvais type de piles pour le téléphone. N'utilisez que les piles rechargeable inclus ou les piles de recharge

(BT162342/BT262342). N'incinerez pas les piles. Celles-ci risqueraient d'exploser.

- Évitez d'utiliser la batterie dans les conditions suivantes:
 - » des températures extrêmes faibles ou élevées auxquelles une batterie peut être soumise pendant l'utilisation, le stockage ou le transport;
 - » Remplacement d'une batterie par un type incorrect pouvant supprimer une protection;
 - » mise au rebut d'une batterie dans un feu ou dans un four chaud, ou écrasement mécanique ou coupure d'une batterie, susceptible de provoquer une explosion;
 - » maintien d'une batterie dans un environnement à très haute température pouvant provoquer une explosion ou la fuite de liquide ou de gaz inflammables;
 - » batterie soumise à une pression de l'air extrêmement faible pouvant provoquer une explosion ou la fuite de liquide ou de gaz inflammables.
22. N'utilisez que les adaptateurs inclus avec ce produit. L'utilisation d'un adaptateur dont la polarité ou la tension serait inadéquate risque d'endommager sérieusement le produit et mettre votre sécurité en péril.
 23. La plaque signalétique appliquée est située au bas ou proximité du produit.

CONSERVEZ CES INSTRUCTIONS

Pile

- N'utilisez que la pile incluse ou l'équivalent. Pour commander une pile de recharge, visitez notre site Web au www.vtechphones.com ou composez le 800-595-9511. Au Canada, visitez le phones.vtechcanada.com ou composez le 800-267-7377.
- Ne jetez pas la pile au feu. Vérifiez les instructions spécifiques de mise aux rebus auprès des autorités locales.
- N'ouvrez pas et ne mutilez pas la pile. L'électrolyte qui s'en échapperait est corrosif et pourrait causer des brûlures ou des blessures aux yeux ou à la peau. L'électrolyte est toxique si avalé.
- Soyez prudents lorsque vous manipulez les piles afin d'éviter les courts-circuits provoqués par des matériaux conducteurs.
- Rechargez la pile incluse avec cet appareil, selon les instructions et limites spécifiées dans ce guide d'utilisation.

Stimulateurs cardiaques implantés dans l'organisme

Les simulateurs cardiaques (s'applique uniquement aux téléphones numériques sans fil):

L'organisme 'Wireless Technology Research, LLC (WTR)', une firme de recherche indépendante, a mené une évaluation pluridisciplinaire des interférences entre les téléphones sans fil portatifs et les stimulateurs cardiaques implantés dans l'organisme. Appuyée par l'Administration des aliments et drogues (FDA) des États-Unis, la firme WTR recommande aux médecins:

Avis aux détenteurs de stimulateurs cardiaques

- Ils doivent tenir le téléphone sans fil à une distance d'au moins six pouces du stimulateur cardiaque.
 - Ils ne doivent PAS placer le téléphone sans fil directement sur le stimulateur cardiaque, tel que dans une poche de chemise, lorsque celui-ci est en marche.
 - Ils doivent utiliser le téléphone sans fil en l'appuyant sur l'oreille qui se trouve dans la direction opposée au stimulateur cardiaque.
- L'étude effectuée par l'organisme WRS n'a pas identifié de risque pour les détenteurs de simulateurs cardiaques causés par les gens qui utilisent un téléphone sans fil à proximité de ceux-ci.

À propos des téléphones sans fil

- **Alimentation électrique:** Les mêmes caractéristiques qui constituent des avantages pour les téléphones sans fil affichent également des restrictions. Les appels téléphoniques sont transmis entre le combiné sans fil et le socle par le biais d'ondes radio ; il y a donc la possibilité que vos conversations téléphoniques sans fil soient interceptées par des équipements de réception radio se trouvant dans la portée du combiné sans fil. Pour cette raison, vous ne devez pas percevoir les communications téléphoniques sans fil comme étant aussi confidentielles.
- **Alimentation électrique:** Le socle de ce téléphone sans fil doit être branché à une prise électrique fonctionnelle. La prise électrique ne doit pas être contrôlée par un interrupteur mural. Les appels ne pourront pas être effectués du combiné sans fil si le socle est débranché ou mis hors tension ou si le courant est coupé.

- **Possibilité d'interférences aux téléviseurs:** Certains téléphones sans fil fonctionnent sur des fréquences pouvant causer des interférences aux téléviseurs et aux magnétoscopes. Pour réduire ou prévenir de telles interférences, ne placez pas le socle du téléphone sans fil près ou sur un téléviseur ou magnétoscope. S'il y a présence de parasites, il est conseillé d'éloigner le téléphone sans fil du téléviseur ou du magnétoscope afin de réduire possiblement les interférences.
- **Piles rechargeables:** Manipulez les piles avec soin afin de ne pas les court-circuiter avec des bagues, bracelets ou clés. Les piles ou le conducteur peut surchauffer et causer des blessures. Respectez la polarité adéquate entre la pile et le chargeur.
- **Les bloc-piles rechargeables à l'hydrure métallique de nickel:** Jetez ces blocs-piles de manière écologique et sécuritaire. Ne les incinerez pas et ne les percez pas. Tel que les autres piles de ce type, elles pourraient dégager une matière toxique qui peut causer des blessures corporelles si elles sont brûlées ou percées.

The RBRC seal

The RBRC seal on the nickel-metal hydride battery indicates that VTech Communications, Inc. is voluntarily participating in an industry program to collect and recycle these batteries at the end of their useful lives, when taken out of service within the United States and Canada.

The program provides a convenient alternative to placing used nickel-metal hydride batteries into the trash or municipal waste, which may be illegal in your area.

VTech's participation makes it easy for you to drop off the spent battery at local retailers participating in the program or at authorized VTech product service centers. Please call **1 (800) 8 BATTERY®** for information on Ni-MH battery recycling and disposal bans/restrictions in your area. VTech's involvement in this program is part of its commitment to protecting our environment and conserving natural resources.

The RBRC seal and 1 (800) 8 BATTERY® are registered trademarks of Call2recycle, Inc.



FCC, ACTA and IC regulations FCC Part 15

This equipment has been tested and found to comply with the requirements for a Class B digital device under Part 15 of the Federal Communications Commission (FCC) rules. These requirements are intended to provide reasonable protection against harmful interference in a residential installation. This equipment generates, uses and can radiate radio frequency energy and, if not installed and used in accordance with the instructions, may cause harmful interference to radio communications. However, there is no guarantee that interference will not occur in a particular installation. If this equipment does cause harmful interference to radio or television reception, which can be determined by turning the equipment off and on, the user is encouraged to try to correct the interference by one or more of the following measures:

- Reorient or relocate the receiving antenna.
- Increase the separation between the equipment and receiver.
- Connect the equipment into an outlet on a circuit different from that to which the receiver is connected.
- Consult the dealer or an experienced radio/TV technician for help.

Changes or modifications to this equipment not expressly approved by the party responsible for compliance could void the user's authority to operate the equipment.

This device complies with Part 15 of the FCC rules. Operation is subject to the following two conditions: (1) this device may not cause harmful interference, and (2) this device must accept any interference received, including interference that may cause undesired operation. Privacy of communications may not be ensured when using this telephone.

To ensure safety of users, the FCC/ISED has established criteria for the amount of radio frequency energy that can be safely absorbed by a user or bystander according to the intended usage of the product. This product has been tested and found to comply with the FCC/ISED criteria. The handset may be safely held against the ear of the user. The telephone base shall be installed and used such that parts of the user's body other than the hands are maintained at a distance of approximately 20 cm (8 inches) or more.

This Class B digital apparatus complies with Canadian requirement:
CAN ICES-3 (B)/NMB-3(B).

FCC Part 68 and ACTA

This equipment complies with Part 68 of the FCC rules and with technical requirements adopted by the Administrative Council for Terminal Attachments (ACTA). The label on the back or bottom of this equipment contains, among other things, a product identifier in the format US:AAAEQ##TXXXX. This identifier must be provided to your telephone service provider upon request.

The plug and jack used to connect this equipment to premises wiring and the telephone network must comply with applicable Part 68 rules and technical requirements adopted by ACTA. A compliant telephone cord and modular plug is provided with this product. It is designed to be connected to a compatible modular jack that is also compliant. An RJ11 jack should normally be used for connecting to a single line and an RJ14 jack for two lines. See the installation instructions in the user's manual.

The Ringer Equivalence Number (REN) is used to determine how many devices you may connect to your telephone line and still have them ring when you are called. The REN for this product is encoded as the 6th and 7th characters following the US: in the product identifier (e.g., if ## is 03, the REN is 0.3). In most, but not all areas, the sum of all RENs should be five (5.0) or less. For more information, please contact your telephone service provider.

This equipment may not be used with Party Lines. If you have specially wired alarm dialing equipment connected to your telephone line, ensure the connection of this equipment does not disable your alarm equipment. If you have questions about what will disable alarm equipment, consult your telephone service provider or a qualified installer.

If this equipment is malfunctioning, it must be unplugged from the modular jack until the problem has been corrected. Replacement to this telephone equipment can only be made by the manufacturer or its authorized agents. For replacement procedures, follow the instructions outlined under the "Limited warranty".

If this equipment is causing harm to the telephone network, the telephone service provider may temporarily discontinue your telephone service. The telephone service provider is required to notify you before interrupting service. If advance notice is not

practical, you will be notified as soon as possible. You will be given the opportunity to correct the problem and the telephone service provider is required to inform you of your right to file a complaint with the FCC. Your telephone service provider may make changes in its facilities, equipment, operation, or procedures that could affect the proper functioning of this product. The telephone service provider is required to notify you if such changes are planned.

If this product is equipped with a corded or cordless handset, it is hearing aid compatible.

If this product has memory dialing locations, you may choose to store emergency telephone numbers (e.g., police, fire, medical) in these locations. If you do store or test emergency numbers, please:

Remain on the line and briefly explain the reason for the call before hanging up.

Perform such activities in off-peak hours, such as early morning or late evening.

Industry Canada

This device contains licence-exempt transmitter(s)/receiver(s) that comply with Innovation, Science and Economic Development Canada's licence-exempt RSS(s).

Operation is subject to the following two conditions: (1) this device may not cause interference, and (2) this device must accept any interference, including interference that may cause undesired operation.

Privacy of communications may not be ensured when using this telephone.

The term "IC:" before the certification/registration number only signifies that the Industry Canada technical specifications were met.

The Ringer Equivalence Number (REN) for this terminal equipment is 0.1. The REN indicates of the maximum number of devices allowed to be connected to a telephone interface. The termination on an interface may consist of any combination of devices subject only to the requirement that the sum of the RENs of all the devices not exceed five.

This product meets the applicable Innovation, Science and Economic Development Canada technical specifications.

California Energy Commission battery charging testing instructions

This telephone is set up to comply with the energy-conserving standards right out of the box. These instructions are intended for California Energy Commission (CEC) compliance testing only. When the CEC battery charging testing mode is activated, all telephone functions, except battery charging, will be disabled.

To activate the CEC battery charging testing mode:

1. Unplug the telephone base power adapter from the power outlet. Make sure all handsets are plugged with charged batteries before proceeding.
2. While you press and hold **FIND HS** on the telephone base, plug the telephone base power adapter back to the power outlet.
3. After about 10 seconds, release **FIND HS** and immediately press it again within two seconds. When the phone successfully enters the CEC battery charging testing mode, all handsets display **To register HS...** and **...see manual** alternately.

If the phone fails to enter this mode, repeat all the steps mentioned above.

To deactivate the CEC battery charging testing mode:

1. Unplug the telephone base power adapter from the power outlet, then plug it back in. Then the telephone base is powered up as normal.
2. Press and hold **FIND HS** on the telephone base for about four seconds.
3. Press **QUIET #** on the handset and it shows **Registering...** The handset shows **Registered** and you hear a beep when the registration process completes. This process takes about 60 seconds.

Install Set up	14	Device list and connection	30		
What's in the box	14	Review the device list	30		
Connect the telephone base	15	Remove a paired device	31		
Connect the charger	15	Download phonebook	31		
Mount the telephone base (optional)	16	Remote voice control	33		
Install the battery	17	Operate	35		
Charge the battery	17	Make, answer or end a home call	35		
Check the battery level	18	Make a home call	35		
Check for dial tone	18	Predial a home call	35		
Before use	19	Answer a home call	35		
Set date and time (before use)	19	End a home call	35		
Set up through voice guide - Smart call blocker (before use)	19	Make, answer or end a cell call	36		
Set up through voice guide - Answering system (before use)	20	Make a cell call	36		
Overview	21	Predial a cell call	36		
Handset	21	Answer a cell call	36		
Telephone base	23	End a cell call	36		
Display	24	View dialing options	36		
Handset lights	24	Sound	37		
Operating range	24	Use speakerphone	37		
Introducing Bluetooth®	25	Volume control	37		
Glossary of terms	26	Mute the microphone	37		
VTech Connect to Cell™ application	27	Temporary ringer silencing	37		
Bluetooth setup	28	Join a call	38		
Pair and connect your Bluetooth enabled cell phone	28	Join a call in progress	38		
Auto connection	30	Call waiting on the home line	38		
		Call waiting on the cell line	39		
		Answer an incoming cell call while on a home call	39		
		Answer an incoming home call while on a cell call	39		
		Intercom	40		
		Initiate an intercom call with a cordless handset	40		
		Answer an incoming home call during an intercom call	41		
		Transfer a call via intercom	41		
		Find handset	42		
		Page/ find handset	42		
		Use phone menu	43		
		Phonebook	44		
		Phonebook Phonebook entry	44		
		Add a phonebook entry	44		
		Review the phonebook entries	45		
		Dial a phonebook entry	46		
		Edit a phonebook entry	46		
		Delete a phonebook entry	46		
		Delete all phonebook entries	46		
		Alphabetical search	47		
		Redial list	48		
		Review a redial list entry	48		
		Dial a redial list entry	48		
		Save a redial entry to the phonebook	48		
		Delete a redial list entry	49		
		Chain dialing	49		
		Caller ID	50		
		Review the caller ID log	51		
		Save a caller ID log entry to the phonebook	51		
		Save a caller ID log entry to allow list	52		
		Save a caller ID log entry to block list	53		
		Save a caller ID log entry to star name list	53		
		Dial a caller ID log entry	53		
		Delete caller ID log entries	54		
		Caller ID memory match	54		
		Missed call indicator	55		
		Smart call blocker*§	55		
		Overview	57		
		Call categories	58		
		Welcome calls	58		
		Unwelcome calls	58		
		Calls without numbers (for home calls only)	58		
		Uncategorized calls (for home calls only)	58		

Contents

Call handling	59	Screening announcements	73	Set languages	85
Set Smart call blocker on/off	61	Play your current announcement of screening with caller name	74	Set LCD language	85
Set profile	61	Play your current announcement of screening without caller name	74	Set Smart call blocker language	86
Block list	62	Record your name for all screening announcements	75	Sound settings	86
Add a block entry	62	Reset all your screening announcements	75	Set number of rings	86
Review block list entries	63	Allowed calls	76	Set QUIET mode	87
Save a caller ID log entry to block list	64	Blocked calls	76	Set listening volume	87
Edit a block list entry	64	Screen unknown home calls	77	Set key tone	87
Unblock a telephone number	65	Screened call options	78	Voicemail settings	88
Delete all block list entries	65	Screen robocalls	79	Set speed dial voicemail number	88
Allow list	66	Option while on a call	81	Add and register handset	88
Add an allow list entry	66	Voicemail (via Telephone service provider)	81	General product care	89
Review allow list entries	67	Clear the new voicemail indicators	82	Technical specifications	90
Save a caller ID log entry to allow list	67	Configure Settings	82	Frequently asked questions	92
Edit a allow list entry	68	Dial modes	82		
Delete an allow list entry	68	Temporary tone dialing	82		
Delete all allow list entries	69	Set dial mode	82		
Star name list	69	Ringer	83		
Add a star name entry	69	Set ringer tone	83		
Review star name list entries	70	Set ringer volume	84		
Save a caller ID log entry to star name list	71	Set date and time	85		
Edit a star name list entry	71				
Delete a star name list entry	71				
Delete all star name list entries	72				
Voice guide to set Smart call blocker	72				

Install | Set up

What's in the box

Your telephone package contains the following items. Save your sales receipt and original packaging in case it is necessary to ship your telephone for warranty service.

You can add new handsets (**LS6300**) to your telephone system. All accessories are sold separately. Your telephone base supports a maximum of five devices.

NOTE

- To purchase replacement batteries or power adapters, visit our website at www.vtechphones.com or call 1 (800) 595-9511. In Canada, go to phones.vtechcanada.com or dial 1 (800) 267-7377.

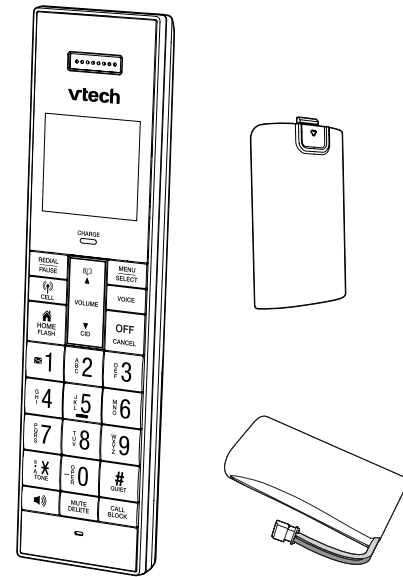

- 1 set for LS6331
- 2 sets for LS6331-2
- 3 sets for LS6331-3
- 4 sets for LS6331-4
- 5 sets for LS6331-5

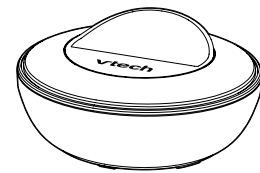

- 1 sets for LS6331-2
- 2 sets for LS6331-3
- 3 sets for LS6331-4
- 4 sets for LS6331-5

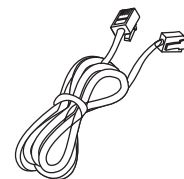
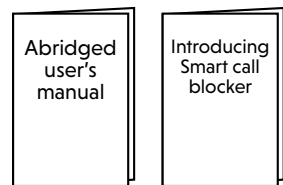
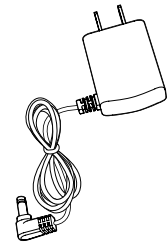
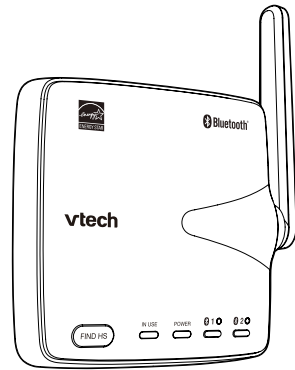
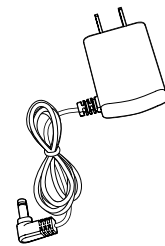

Connect the telephone base Connect the charger

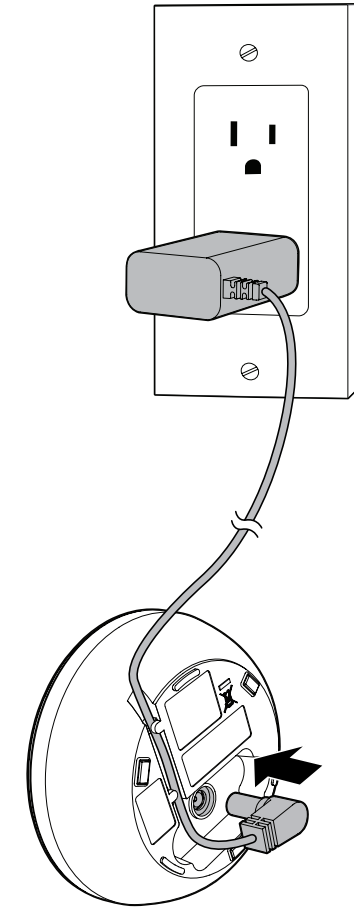
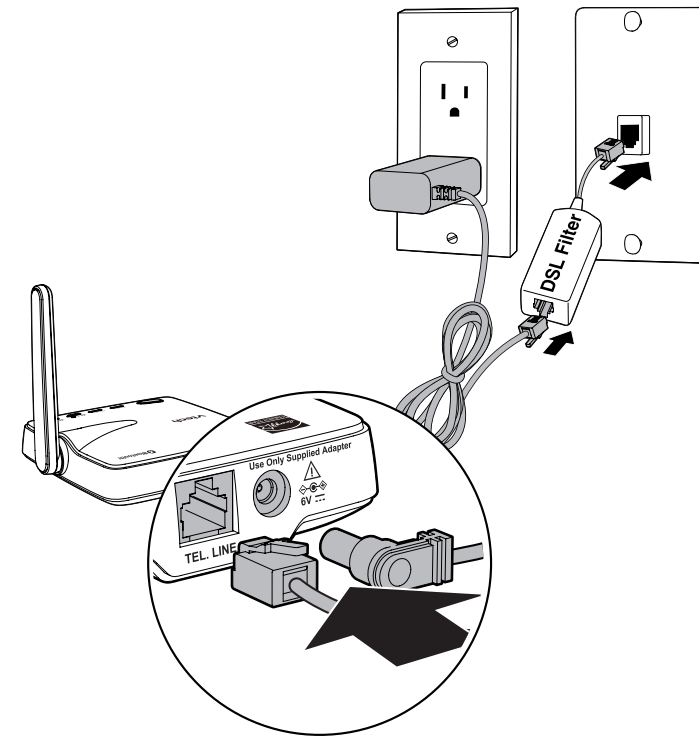

TIPS

- If you want to mount the base, make sure telephone line pass through the mounting bracket before connecting to the DSL filter.
- If you subscribe to digital subscriber line (DSL) high-speed Internet service through your telephone line, make sure you connect a DSL filter (not included) to the telephone wall jack.

Mount the telephone base (optional)

1. Use a pencil to mark two holes on the wall in parallel.

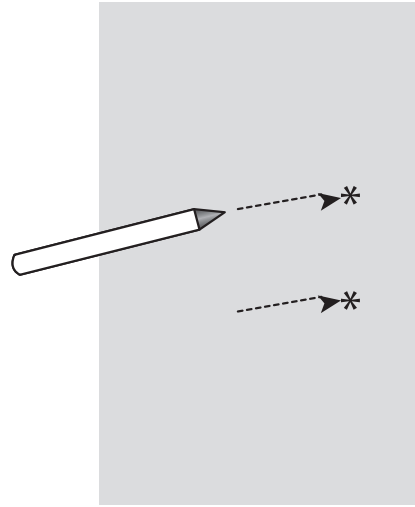

2. Drill two holes in the wall. If you drill the holes into a stud, go to the next step.

- If you drill the holes into an object other than a stud, insert the wall anchors into the holes. Tap gently on the ends with a hammer until the wall anchors are flush with the wall.

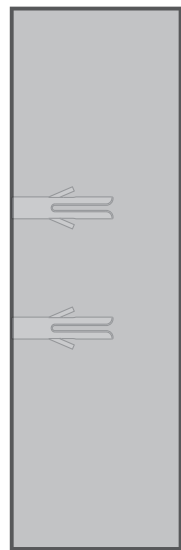

3. Insert the screws into the holes and tighten the screws until only 1/4 inch of the screws are exposed.

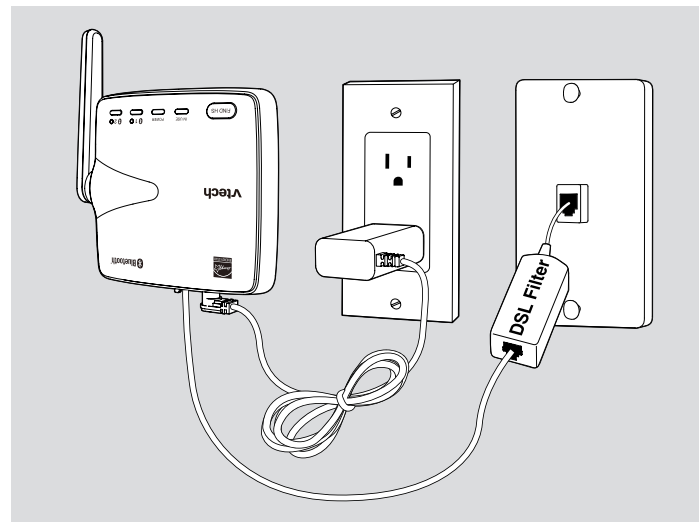
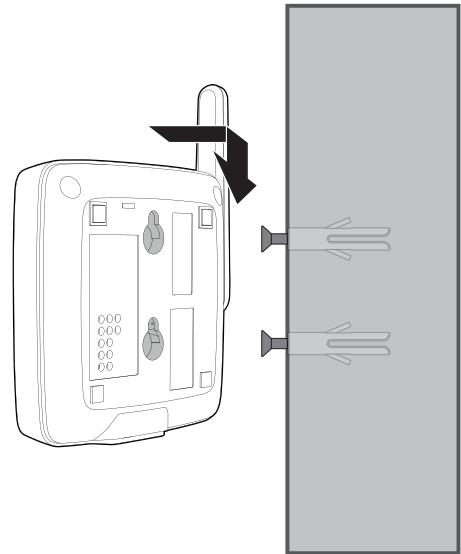
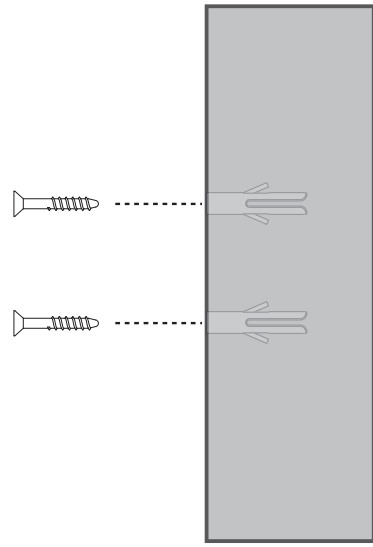

Install the battery

4. Plug the battery connector securely into the socket inside the handset battery compartment.
 - Make sure the battery label **THIS SIDE UP** is facing up, as indicated.

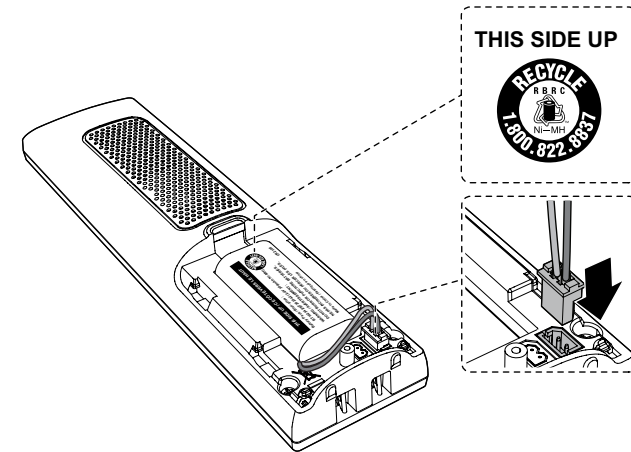

5. Align the cover flat against the battery compartment, then slide it upwards until it clicks into place.

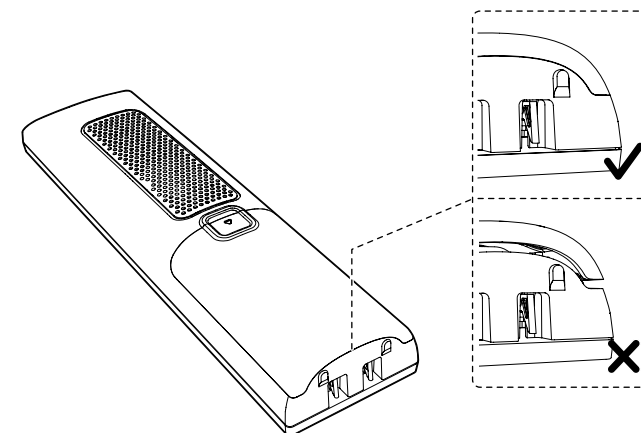
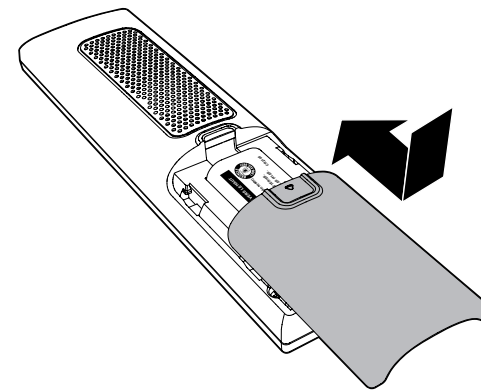

Charge the battery

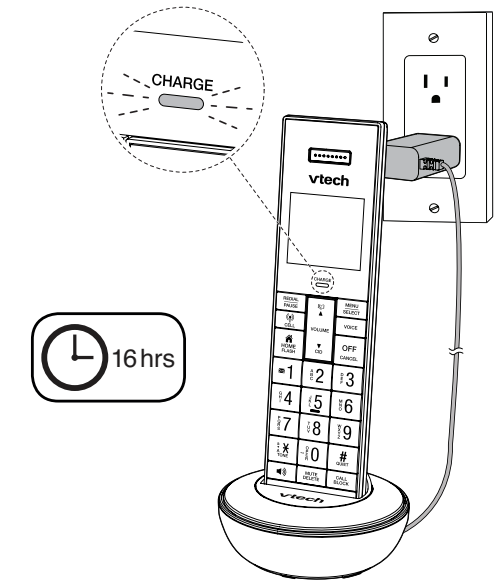

The following table summarizes the battery indicators and actions to take.

Battery indicators	Battery status	Action
<ul style="list-style-type: none"> • The screen is blank, or shows Put in charger and flashes. 	<ul style="list-style-type: none"> • The battery has no charge or very little charge. The handset cannot be used. 	<ul style="list-style-type: none"> • Charge without interruption (at least 30 minutes).
<ul style="list-style-type: none"> • The screen shows Low battery and flashes. 	<ul style="list-style-type: none"> • The battery has enough charge to be used for a short time. 	<ul style="list-style-type: none"> • Charge without interruption (at least 30 minutes).
<ul style="list-style-type: none"> • The screen shows HANDSET X. 	<ul style="list-style-type: none"> • The battery is charged. 	<ul style="list-style-type: none"> • To keep the battery charged, place it in the handset charger when not in use.





When it is fully charged, you can expect the following performance:

Operation	• Operating time *
Talk time (cordless handset)	• 10 hours
Standby	• 5 days

* Operating times vary depending on your actual use and the age of the battery.

Check the battery level

After you have installed the battery, check the battery level on the handset screen.

- If the screen is blank, or  flashes, then the battery needs to be charged. Go to **Charge the battery** section before you do any setting or operation.
- If the battery icon is , , or , then go to **Set the date and time**, **Set Smart call blocker through voice guide** and **Set the answering system through voice guide** section.

Check for dial tone

Lift the corded handset, or press  **HOME/FLASH** on the cordless handset. If you hear a dial tone, the installation is successful.

If you do not hear a dial tone

- Make sure the installation procedures are properly done.
- The handset may take a second or two to find the telephone base and produce a dial tone. This is normal. Wait an extra second before dialing.
- If the previous suggestions do not work, disconnect the telephone line cord from your telephone and connect the telephone line cord to another telephone.
- If there is no dial tone on that other telephone either, your telephone line cord may be defective. Install a new telephone line cord.
- If changing the telephone line cord does not help, the wall jack (or the wiring to this wall jack) may be defective. Try using a different wall jack in your home to connect your **LS6331/LS6331-2/LS6331-3/LS6331-4/LS6331-5** telephone, or contact your telephone service provider (charges may apply).

Before use

Set date and time (before use)

After you install your telephone or power returns following a power outage and battery depletion, the handset will prompt you to set the date and time, and to configure the Smart call blocker and answering system through voice guide.

NOTE

- Make sure you set the date and time including the year correctly; otherwise the answering system does not announce the correct day of the week for your recorded messages time stamp.
1. Use the dialing keys (**0-9**) to enter the month (**MM**), date (**DD**) and year (**YY**). Then, press **MENU/SELECT**.
 2. Use the dialing keys (**0-9**) to enter the hour (**HH**) and minute (**MM**). Then press **▼ CID** or **▲**  to choose **AM** or **PM**.
 3. Press **MENU/SELECT** to save.

After setting the date and time, the handset will prompt if you want to set **Smart call blocker (before use)**.

TIP

- To skip setting the date and time, press **OFF/CANCEL** on the handset.

Set up through voice guide - Smart call blocker (before use)

After the date and time setting is done or skipped, the handset will then prompt if you want to set up Smart call blocker.

This feature is an easy and alternative way for you to do the basic setup of Smart call blocker.

You can follow the voice guide to set your telephone system to allow or to screen all incoming home calls.

1. Press **MENU/SELECT** to start the Smart call blocker setup via voice guide. You hear the voice prompt "*Hello! This voice guide will assist you with the basic setup of Smart call blocker...*"
 - To skip the set up, press **OFF/CANCEL** on the handset.
2. Set up your Smart call blocker feature by inputting the designated numbers, as instructed in the voice guide.

After setting Smart call blocker, the handset will prompt if you want to set **Answering system (before use)**.

Set up through voice guide - Answering system (before use)

This feature assists you to do the basic setup of the answering system. You can follow the voice guide to record your own announcement, set the number of rings and the message alert tone.

1. Press **MENU/SELECT** to start the answering system setup via voice guide. You hear the voice prompt *"This voice guide will assist you with the basic setup of your answering system."*

- To skip the set up, press **OFF/CANCEL** on the handset.

2. Setup your answering system by inputting the designated numbers as instructed in the voice guide.

Alternate way to set up Smart call blocker

1. Press **CALL BLOCK** on the handset to enter Smart call blocker menu.

- OR -

Press **MENU/SELECT** to enter the main menu. Press **▼ CID** or **▲** to scroll to **Smart call blk**, and then press **MENU/SELECT**.

2. Press **▼ CID** or **▲** to scroll to **Voice guide**, the press **MENU/SELECT**. You hear the voice prompt *"Hello! This voice guide will assist you with the basic setup of Smart call blocker..."*

3. Set up your Smart call blocker by inputting designated numbers as instructed in the voice guide.

NOTE

- You can press **OFF/CANCEL** on the handset to quit the voice guide at any time.

Alternate way to set up Answering system

1. Press **MENU/SELECT** on the handset in idle mode.

2. Press **▼ CID** or **▲** to scroll to **Answering sys**, and then press **MENU/SELECT**.

3. Press **▼ CID** or **▲** to scroll to **Voice guide**, the press **MENU/SELECT**. You hear the voice prompt *"This voice guide will assist you with the basic setup of your answering system."*

4. Set up your answering system by inputting designated numbers as instructed in the voice guide.

NOTE

- You can press **OFF/CANCEL** on the handset to quit the voice guide at any time.

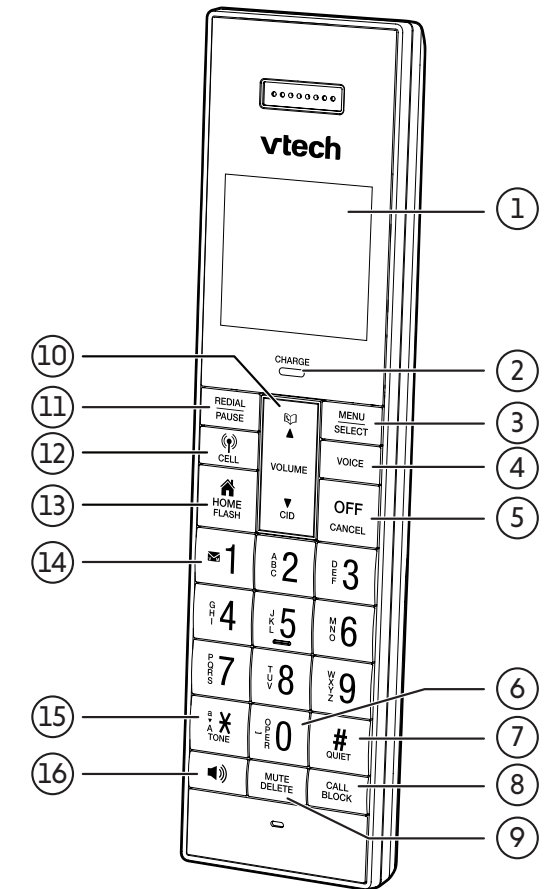

Overview

Handset



1	LCD display	
2	CHARGE light	
3	MENU/SELECT	<ul style="list-style-type: none"> • Display the menu. • Select an item or save an entry or setting while in the menu.
4	VOICE	<ul style="list-style-type: none"> • Activate the voice-controlled application of one of the connected devices when the system is in idle. If there is no paired device, then the handset will prompt Pair cell first to remind you for remote voice control activation.



5	OFF/ CANCEL	<ul style="list-style-type: none"> Hang up a call. Return to the previous menu or idle mode without making changes. Delete digits while predialing. Silence the handset ringer temporarily while the phone is ringing. <u>Press and hold</u> to erase the missed call indicator while the handset is not in use.
	OPER 0	<ul style="list-style-type: none"> Enter space character during text editing.
7	QUIET #	<ul style="list-style-type: none"> <u>Press and hold</u> to set and turn on the QUIET mode, or turn it off. When reviewing a caller ID log entry, press repeatedly to view other dialing options.
8	CALL BLOCK	<ul style="list-style-type: none"> Block the incoming call when the telephone is ringing. When on a call, press to block the call. Show the Smart call blocker menu when idle.
	MUTE/ DELETE	<ul style="list-style-type: none"> Mute the microphone during a call. Mute the ringer temporarily when the handset is ringing. Delete an individual entry while reviewing the caller ID log, the phonebook or the redial memory. Delete digits while predialing. Delete the playing message or the recorded announcement during message or announcement playback.
10		<ul style="list-style-type: none"> Show phonebook entries.
	CID	<ul style="list-style-type: none"> Review the caller ID log.

10	▲ VOLUME/ VOLUME ▼	<ul style="list-style-type: none"> Move the cursor to the left or right while entering names or numbers. Increase or decrease the listening volume when on a call, or increase or decrease the message playback volume.
	11 REDIAL/ PAUSE	<ul style="list-style-type: none"> Review the redial list. Insert a dialing pause while dialing or entering numbers into the phonebook.
12	 CELL	<ul style="list-style-type: none"> Make or answer a cell call. Answer an incoming cell call when you hear a call waiting alert during a cell call. Call back the caller if the caller's number is available while reviewing caller ID log.
	13 HOME/ FLASH	<ul style="list-style-type: none"> Make or answer a home call. Answer an incoming home call when you hear a call waiting alert. Call back the caller if the caller's number is available while reviewing caller ID log.
14	 1	<ul style="list-style-type: none"> While reviewing a caller ID log entry, press repeatedly to add or remove 1 in front of the telephone number before dialing or saving it in the phonebook. <u>Press and hold</u> to set or dial your voicemail number.
	15 TONE X / a ▶ A	<ul style="list-style-type: none"> Switch to tone dialing temporarily during a call if you have pulse service. Change the next letter to upper or lower case while entering names.

16		<ul style="list-style-type: none"> Make or answer a home call or cell call using the speakerphone. Turn on or off the handset speakerphone.
----	-------------------------------------------------------------------------------------	---------------------------------------------------------------------------------------------------------------------------------------------------------------------

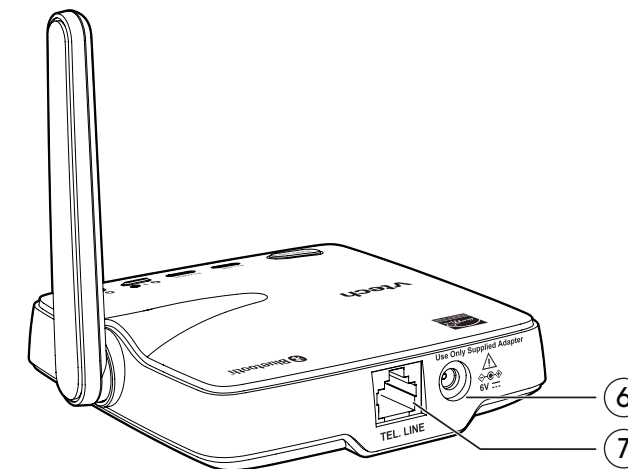
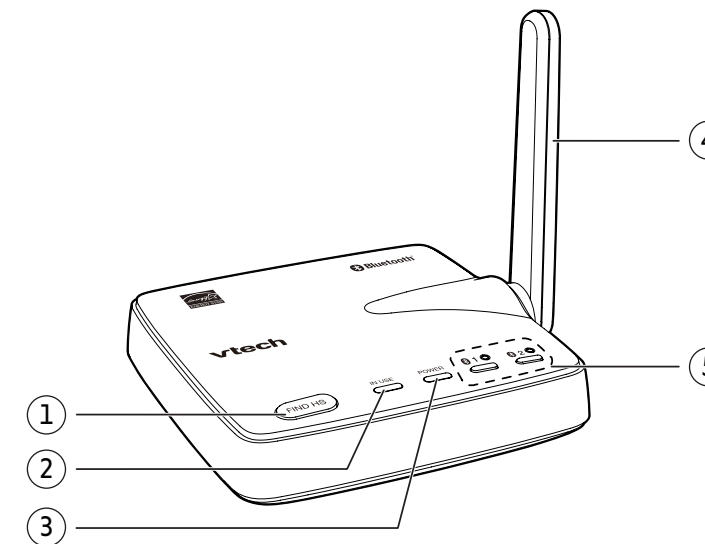
Telephone base



1	FIND HS	<ul style="list-style-type: none"> Page all system handsets.
	2 IN USE light	<ul style="list-style-type: none"> On when the handset is in use, or when the telephone base is registering a handset. Flashes when there is an incoming call, or another telephone sharing the same line is in use. Flashes slowly when the telephone base is deregistering all handsets.
3	POWER light	<ul style="list-style-type: none"> On when the telephone base is connected to power supply.
	4 Antenna	
5	 1 (Slot 1)  2 (Slot 2)	<ul style="list-style-type: none"> <u>Press and hold</u> to pair a new Bluetooth device or replace a Bluetooth device. Press to connect the paired Bluetooth device. Light off when no Bluetooth device is paired or when paired device is not connected. Light on when the telephone base is paired and connected with a Bluetooth device. Light flashes when the telephone base is in pairing mode.
	6 Power jack	
7	Telephone line jack	



1	CHARGE	<ul style="list-style-type: none"> On when the handset is charging in the handset charger.
2		<ul style="list-style-type: none"> On when the speakerphone is in use.

Operating range

This cordless telephone operates with the maximum power allowed by the Federal Communications Commission (FCC). Even so, this handset and telephone base can communicate over only a certain distance which can vary with the locations of the telephone base and handset, the weather, and the layout of your home or office.

When the handset is out of range, the handset displays **Out of range or no pwr at base**.

If there is a call while the handset is out of range, it may not ring, or if it does ring, the call may not connect well when you press **HOME/FLASH**. Move closer to the telephone base, and then press **HOME/FLASH** to answer the call. If the handset moves out of range during a telephone conversation, there may be interference. To improve reception, move closer to the telephone base.

1		<ul style="list-style-type: none"> The handset battery is low and needs charging.
2		<ul style="list-style-type: none"> The handset battery is charging.
3		<ul style="list-style-type: none"> The handset battery is fully charged.
4		<ul style="list-style-type: none"> Ringer is off.
5		<ul style="list-style-type: none"> New voicemail received from your telephone service provider.
6	NEW	<ul style="list-style-type: none"> The entry you are reviewing is new in the caller ID log.
7		<ul style="list-style-type: none"> Displays when Home line is in use.
8		<ul style="list-style-type: none"> Bluetooth device is paired and active.
9		<ul style="list-style-type: none"> Bluetooth device / Cell line is in use.
10	ECO	<ul style="list-style-type: none"> The ECO mode activates automatically to reduce power consumption when the handset is within range of the telephone base.

Introducing Bluetooth®

Your new **LS6331/LS6331-2/LS6331-3/LS6331-4/LS6331-5** telephone system with Bluetooth wireless technology has the following features:

- Pair and connect up to two Bluetooth enabled cell phones with the telephone base.
- Receive calls using your cell phone service with your telephone base or system handsets.
- Download phonebook entries from your cell phone.

IMPORTANT INFORMATION

- Your **LS6331/LS6331-2/LS6331-3/LS6331-4/LS6331-5** is compatible with Bluetooth version 2.0 or above devices.
- After plugging in the telephone base, wait at least 20 seconds before connecting a Bluetooth device.
- Refer to the user's manual of your Bluetooth enabled cell phone for more information about how that device uses Bluetooth connectivity.
- Bluetooth wireless technology operates within a short range (a maximum of approximately 15 feet) from the telephone base. Keep connected cell devices within this range.

The Bluetooth® word mark and logos are owned by Bluetooth SIG, Inc. and any use of such marks by Advanced American Telephones and its parent, VTech Holdings Limited, is under license. VTech Holdings Limited is a member of Bluetooth SIG, Inc. Other trademarks and trade names are those of their respective owners.

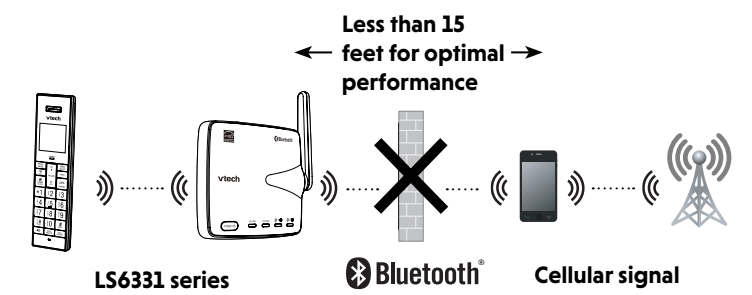

- If your Bluetooth device has poor reception in your home, the **LS6331/LS6331-2/LS6331-3/LS6331-4/LS6331-5** cannot improve the reception. However, if there is a location in your house with better reception, you can leave your Bluetooth device at that location while you use the **LS6331/LS6331-2/LS6331-3/LS6331-4/LS6331-5** cell line. For optimal performance, the device must be within 15 feet of the telephone base.
- If you experience poor sound quality, it may be caused by the distance between your Bluetooth device and the telephone base. To improve the performance, place your device closer to the telephone base (within 15 feet) and make sure that there are no physical obstacles such as large furniture or thick wall in between.
- Charge your cell phone while it is connected to the telephone base. Your cell phone's battery discharges faster while it is connected to the telephone base via Bluetooth wireless technology.

- Monitor your cell phone's usage, because minutes may be deducted from your cellular plan for the duration of all cell calls, depending on the terms of your plan.

Refer to the **Bluetooth setup** section to learn how to set up your Bluetooth device. Refer to the **Telephone operation** section on how to operate your Bluetooth devices with your new telephone system with Bluetooth wireless technology.

Glossary of terms

Below are some terms used in this user's manual to help you become familiar with using your Bluetooth devices and your new VTech telephone system.



Active device slots - the **Device list** has two active slots for two cell phones. In order to use a Bluetooth device on a call, it must be in an active slot and be connected.

Bluetooth cell phone - refers to a mobile Bluetooth enabled cellular telephone.

CELL line - the telephone line associated with your cell phone service. Press  **CELL** on your handset to use the cell line.

Connected - when you pair a Bluetooth device to your telephone system, it is placed in an active slot and automatically connected. When a device is connected, a **1** and/or **2** will display after  on the handset screen. If a device loses its connection to the telephone base, it must be reconnected before you can use the device with the telephone system.

Device list - The list of devices that have been paired to the telephone. You can pair up to 2 Bluetooth enabled cell phones.

Disconnected - when device(s) is/are disconnected, ¹ and/or ₂ is/are not displayed on the handset screen.

Discoverable mode - before a Bluetooth enabled device can be paired, it must be set to this mode. When pairing your cell phone, the telephone base will be set to this mode. Depending on the manufacturer, this mode is sometimes referred to as **Find Me** or **Visibility**.

HOME line - your conventional telephone land line. On your telephone system, press  **HOME/FLASH** on the handset to use the home line.

Paired devices - The Bluetooth enabled cell phones that have shared registration information with the telephone base. A total of two Bluetooth enabled cell phones can be paired to the telephone base. However, only one paired device can communicate with the base at a time.

Pairing - sometimes referred to as **bonding**. The process of sharing registration information between two Bluetooth enabled devices. Your Bluetooth enabled cell phone must first be paired to the telephone base in order to use it with this telephone system.

VTech Connect to Cell™ application

If you are using Bluetooth-enabled Android® phones (OS 2.3 or higher), you can further extend the flexibility of your telephone system with use of the free **Connect To Cell** application.

VTech **Connect to Cell** comprises **Caller ID manager** and **Alerts manager** that help you integrate your cell phone with your new telephone system.

To learn more or download this application via Google Play® Store, go to https://www.vtechphones.com/app_connect_to_cell.



Bluetooth setup

To use a Bluetooth enabled device with your **LS6331/LS6331-2/LS6331-3/LS6331-4/LS6331-5**, you must first pair and connect it with the telephone base. The **LS6331/LS6331-2/LS6331-3/LS6331-4/LS6331-5** system handsets can be used to make or answer calls on the cell phone line.

Bluetooth wireless technology operates within a short range (up to 15 feet). When you pair a Bluetooth device to the telephone base, keep the device within 15 feet of the telephone base for optimal performance.

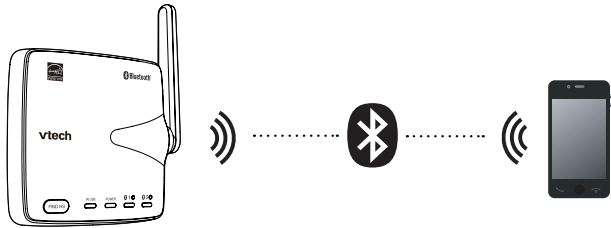









Pair and connect your Bluetooth enabled cell phone

You can pair up to two cell phones to the telephone. To use a paired device, it must be paired and connected.

Before you begin, make sure that you have cellular coverage and your Bluetooth enabled cell phone is not connected to any other Bluetooth device. Refer to your cell phone user's manual to learn how to search for or add new Bluetooth devices.

Pair and connect Bluetooth enabled cell phone:

1. Choose Bluetooth device slot 1 or 2. Press and hold  1 or  2 on the telephone base for about 4 seconds until the  1 or  2 light flashes.
 - If there is already a cell phone paired to the slot, the existing cell phone will be removed from the cell devices list.
2. Turn on the Bluetooth feature of your cell phone and search for or add new devices. Once your cell phone finds your VTech phone (**VTech DECT 6.0**), press the appropriate key on your cell phone to continue the pairing process.
 - All cell phones that are connected to the telephone base are disconnected temporarily until the pairing process is complete.

When a Bluetooth device is successfully paired and connected to the telephone, the corresponding status icon ( 1 or  2) displays on the handset. The corresponding device light on the telephone base ( 1(slot 1) or  2(slot 2)) turns on.

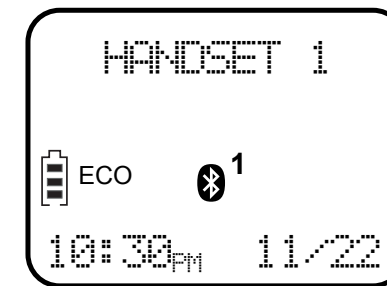

NOTES

- To use a Bluetooth enabled cell phone with your telephone system, you must first pair and connect your Bluetooth cell phone with the telephone base.
- When you pair a Bluetooth cell phone to the telephone base, place your Bluetooth cell phone closer to the telephone base to maintain sufficient signal strength.
- The pairing process may take up to one minute. If the pairing process fails, try again.
- The steps for the pairing process may vary for different cell phones. If this happens, follow the prompts on your cell phone and your **LS6331/LS6331-2/LS6331-3/LS6331-4/LS6331-5** to complete the pairing process.

- If you have trouble pairing your Bluetooth cell phone to the telephone base, try turning off the Bluetooth feature of the nearby devices that your cell phone has previously paired.
- Refer to the user's manual of your cell phone on how to search for or add a new Bluetooth device.

Auto connection

When an active device moves within Bluetooth range of the telephone base, or is turned on within range, the telephone base tries to connect to the device. When the device moves out of range, it is disconnected. Your device might make a connect or disconnect sound.

A connected device could also be disconnected by:

- Turning off the Bluetooth device.
- Turning off the Bluetooth feature of the device.
- The Bluetooth device is not within range of the telephone base.

The telephone will try to auto-connect to the devices that have disconnected within 60 minutes. When auto-connection is timed out, the LED of the selected device slot will turn off.

Connect a paired device

If you need to connect your paired cell phone to the telephone base manually:

1. Press **1** or **2** on the telephone base when it is not in use, and its light flashes.
2. When the cell phone is connected to the telephone base, the corresponding status icon (**1** or **2**) displays on the handset screen. The corresponding device light (**1** or **2**) turns on.

Device list and connection

Up to two devices can be paired to the telephone base. All paired devices are shown on the device list. To use a paired device, it must be connected and in an active slot (**1:** or **2:**) on the device list. Only one active device can be on a call at a time.

NOTE

- When connecting a Bluetooth device to the device list, all connected devices will be temporarily disconnected until the procedure is complete. It may take up to two minutes to reconnect.

Review the device list

You can check what devices you have paired to the telephone system.

1. Press **MENU/SELECT** on the handset when it is not in use to enter the main menu.
2. Press **▼CID** or **▲** to highlight **Bluetooth**, then press **MENU/SELECT**.
3. Press **MENU/SELECT** again to select **Device list**.

NOTE

- When a device (**1:** or **2:**) is displayed on the handset screen, press **MUTE/DELETE** will remove the device.

Remove a paired device

When you already have 2 devices on the device list and you want to add another device, you must first delete one from the list. You can only pair up to 2 cell phones.

To remove a paired device:

1. Press **MENU/SELECT** on handset when it is not in use to enter the main menu.
2. Press **▼CID** or **▲** to highlight **Bluetooth**, then press **MENU/SELECT**.
3. Press **▼CID** or **▲** to highlight **Device list**, then press **MENU/SELECT**.
4. Press **▼CID** or **▲** to highlight the desired device, then press **MUTE/DELETE**.

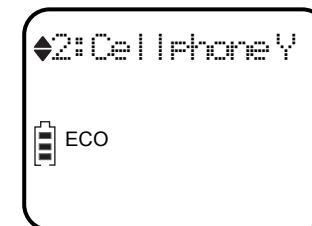

Download phonebook

You can download cell phone phonebook entries to your **LS6331/LS6331-2/LS6331-3/LS6331-4/LS6331-5** telephone system via Bluetooth wireless technology. Each downloaded cell phone phonebook entry are stored in the telephone phonebook with up to 30 digits for each phone number and 15 characters for each name.

Before downloading a phonebook, make sure the cell phone is paired, active, and connected to your telephone system. Place your cell phone next to the telephone base when you download a cell phone phonebook to your telephone system.

To download contacts from your Bluetooth cell phone:

1. Press **MENU/SELECT** when the handset is not in use to enter the main menu.
2. Press **▼CID** or **▲** to highlight **Bluetooth**, then press **MENU/SELECT**.
3. Press **▼CID** or **▲** to highlight **Download PB**, then press **MENU/SELECT**.
 - If you have two paired devices, the handset displays **Select a device** briefly.
 - If there is no cell phone paired to the system, the handset displays **Pair cell first** and then returns to the previous menu.

4. Press **▼CID** or **▲** to highlight a device, then press **MENU/SELECT**.

- If the selected device is not available, the handset returns to the previous menu.

During the download, the handset flashes **Downloading...** All other idle system handsets display **Downloading...**

5. When the downloading process completes or when the memory is full, the handset displays **Entries added: XXX**. Then the handset returns to the **Bluetooth** menu.

NOTES

- For certain cell phones, you may need to press a key on your cell phone to confirm the phonebook download.
- Certain cell phones do not support SIM card download. If this is the case, transfer the contacts from your SIM card to your cell phone memory first. Then download from your cell phone memory. For more information on how to transfer contacts from your SIM card to your cell phone memory, see the user's manual of your cell phone.

- When downloading the phonebook from your Bluetooth enabled cell phone, some data may not transfer. For example, if you have home, mobile and work numbers for a particular contact, the three category descriptions may not transfer to your telephone system.
- The telephone system will remove any duplicate entries, and any entries that contain unrecognizable symbols; therefore, the number of entries downloaded from your cell phone phonebook may be less than the number of entries stored in your cell phone.

Remote voice control

If you have connected a cell phone to the **LS6331/LS6331-2/LS6331-3/LS6331-4/LS6331-5** telephone system, you can activate the voice-controlled application (voice app) of the cell phone, such as Siri®, Google Now™ or S Voice®, using your handset or telephone base.

The remote voice control feature works with:

Voice-controlled application	Siri	Google Now	S Voice
Operation System (Versions supported)	iOS (8 or above)	Android (4 or above)	Android (4 or above)

Before using the remote voice control feature, make sure you checked the following:

- Your cell phone is paired and connected to your telephone system via Bluetooth.
- No Bluetooth applications are running in the background of your cell phone.
- Place your cell phone next to the telephone base.
- Do not lock your cell phone's screen or set passcode for activating the voice app.

Siri® is a registered trademark of Apple Inc.
 Google Now™ is a trademark of Google Inc.
 S Voice® is a registered mark of Samsung Electronics Co., Ltd.
 IOS is a trademark or registered trademark of Cisco in the U.S. and other countries and is used under license.



- Make sure you have turned on or logged in to the applications on your cell phone that you will be sending your voice commands, such as GPS, email and social networking accounts.
- Your cell phone's data or Wi-Fi signal is in full strength and your cell phone can connect to the Internet.
- Try to activate the voice app on your cell phone to ensure it is in place.

Activate remote voice control on handset

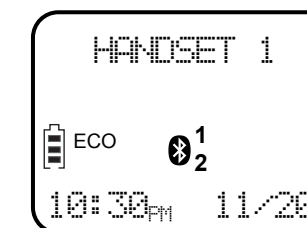
1. Press **VOICE** on the handset.



- If you have connected one cell phone to the telephone, the handset shows the device name of the connected cell phone directly.
- If you have connected two cell phones to the telephone, the handset shows **Select a device**, followed by the device name list of the connected cell phones. Press **▼CID** or **▲** to highlight the desired device, then press **MENU/SELECT**.

- If there is no cell phone paired to the system, the handset displays **Pair cell first** and then returns to the previous menu.
2. The handset then shows the remote voice control icon .
 - If the activation fails, the handset displays **Not available**. When the screen returns to idle, try Step 1 again.
 3. When the handset plays the confirmation tone as forwarded by the cell phone's voice app, start speaking toward the handset, and then wait for feedback. Make reply to the voice app's feedback, if necessary.
 - You can press  on the handset to turn off the speakerphone and listen to the feedback through the handset earpiece.



4. To end the current remote voice control session, press **OFF/CANCEL** on the handset. You can restart by following Steps 1-3 mentioned above.

NOTES

- Once you have activated the remote voice control feature, you are using your cell phone's voice app to operate your cell phone.
- Please check the cell phone user's manual and the voice app's help topics to find out what commands you can use and any limitations of the voice app.
- Some cell phone manufacturers or network carriers may customize the phone's operating system and implement their own voice app. If you want to use Google Now, you need to manually set it as your default voice app. For detailed instructions, refer to your cell phone user's manual, or contact your cell phone's manufacturer or network carrier. You may also go to "Google Product Forums" on the Internet and check the corresponding help topics.
- Due to the settings of certain cell phones and voice apps, your cell phone may not support the remote voice control feature. Contact your cell phone's manufacturer or network carrier, or check the voice app's help topics if you encounter any problems.
- During the remote voice control activation, if your Android cell phone comes with both a dedicated voice app and Google Now, it may prompt you to select which voice app to use, and whether use it for just once or always. Select the desired options.

If you do not respond to your cell phone's prompt in time, the handset screen will return to idle, and the  icon will disappear. You can restart by following Steps 1-3 mentioned above.

- If you receive a landline or cell line incoming call when you have activated remote voice control on a connected cell phone, the remote voice control operation will be ended.
- The feature may be ended automatically by your cell phone. For example, a cell call has been established via the remote voice control feature and the call has just ended.
- If you need to press dialing keys (**0-9**, **TONEX** or **QUIET#**) during a cell call, please make the call using the cell lines of your telephone system instead of using the voice app via the remote voice control feature (see **Make, answer or end a cell call** section).



Operate

Make, answer or end a home call

Make a home call

Press  **HOME/FLASH** or  on the handset, then enter the telephone number.

Predial a home call

Enter the telephone number, then press  **HOME/FLASH** or  to dial.

- When entering numbers, press **MUTE/DELETE** or **OFF/CANCEL** to make corrections.

Answer a home call

Press  **HOME/FLASH** or , or any dialing keys (**0-9** or **TONE X** or **QUIET#**).

End a home call

Using a cordless handset

Press **OFF/CANCEL** or put the handset in the handset charger.



NOTES

- The screen displays **Unable to call** if the telephone line is in use.
- The screen shows the elapsed time as you talk (in hours, minutes and seconds).

- When entering numbers, press and hold **REDIAL/PAUSE** to insert a dialing pause (a **P** appears).

Make, answer or end a cell call

Make a cell call

1. Press  **CELL** on the handset, then enter the telephone number. The handset displays **Select a device**.
 - If you have only one cell phone connected to the telephone base, press **MENU/SELECT** to select the only device.
 - If you have two cell phones connected to the telephone, press **▼CID** or **▲**  to select a cell phone and then press **MENU/SELECT**.
2. Enter the telephone number, then press  **CELL** dial.



Predial a cell call

1. Enter the telephone number.
2. Press  **CELL** to dial.
 - If you have only one cell phone connected to the telephone base, it is automatically selected to make cell calls.
 - If you have connected two cell phones to the telephone, the handset shows **Select a device**, followed by the device name list of the connected cell phones.

Press **▼CID** or **▲**  to highlight the desired device, then press **MENU/SELECT**.

- When entering numbers, press **MUTE/DELETE** or **OFF/CANCEL** to make corrections.

Answer a cell call

Press  **CELL** or , or any dialing keys (**0-9** or **TONE X** or **QUIET#**).

End a cell call

Press **OFF/CANCEL** or put the handset in the handset charger.

View dialing options

The incoming caller ID log entries have 10 digits (the area code plus the seven-digit number). You can add **1** in front of the telephone number before you dial in the caller ID log or store to the phonebook.

While reviewing the caller ID log, press **#** (pound key) or **1** repeatedly if you need to add or remove **1** in front of the telephone number before dialing or saving it in the phonebook.

When the number shows the correct format for dialing:

- Press **HOME/FLASH** or  on the handset to call the number.

Sound

Use speakerphone

Handset speakerphone

During a call, press  to switch between the speakerphone and normal handset use.

To hand up, press **OFF/CANCEL** or return the handset to handset charger.

Volume control

To adjust the listening volume on a cordless handset

During a call, press **VOLUME▼** or **VOLUME▲** to adjust the listening volume.

NOTES

- The handset and speakerphone volume settings are independent.
- When the volume reaches the minimum or maximum setting, you hear two beeps.

Mute the microphone

Use the mute function to turn off the microphone. You can hear the caller, but the caller cannot hear you.

To mute a call

While on a call, press **MUTE/DELETE**. The handset screen displays **Muted** until the mute function is turned off.

To end mute a call

Press **MUTE/DELETE** on the handset again and resume speaking. The handset screen briefly displays **Microphone on**. Mute is automatically cancelled when you end the call.

Temporary ringer silencing

When the telephone is ringing, you can temporarily silence the ringer of the handset without disconnecting the call. The next call rings normally at the preset volume.

To silence the handset ringer

Press **OFF/CANCEL** or **MUTE/DELETE** on the handset. The handset screen shows **Ringer muted** and .

Join a call

Join a call in progress

You can use two cordless handsets at a time on an outside call. Another handset can join you on a home or cell call. The call continues until all parties hang up.

To join a call with a cordless handset

- When a handset is already on a call, press **HOME/FLASH** or **⏸** on another handset to join the call.
- Press **OFF/CANCEL** or place the handset in the handset charger to exit the call. The call continues until both devices hang up.

Call waiting on the home line

If you subscribe to call waiting service from your telephone service provider, and someone calls while you are already on a call on the home line, the handset flashes **🏠**, and you hear an alert tone.

1. Press **🏠 HOME/FLASH** on the handset to put your current call on hold and take the new call.
2. Press **🏠 HOME/FLASH** on the handset at any time to switch back and forth between calls.

If you also subscribe to caller ID service, it will let you see the name and telephone number of the caller during call waiting. It may be necessary to change your telephone service to use this feature. Contact your telephone service provider if:

- You have both caller ID and call waiting, but as separate service (you may need to combine these services);
- You have only caller ID service, or only call waiting service; or
- You do not subscribe to caller ID or call waiting services.

There are fees for caller ID services. In addition, services may not be available in all areas.

Call waiting on the cell line

If you subscribe to call waiting service from your cell phone service provider, and someone calls while you are already on a call on the cell line, the handset flashes **📶**, and you hear a beep.

1. Press **📶 CELL** on the handset to put your current call on hold and take the new call.
2. Press **📶 CELL** on the handset at any time to switch back and forth between calls.

📄 NOTES

- If the Smart call blocker feature is on and in screening mode, and you receive a call waiting cell call:
 - If you have already picked up a screened home call, the telephone checks whether the call waiting call's number can be found in the block list. If yes, the telephone displays **Blocked call** and rejects the call.
 - If the telephone is screening a home call, the call waiting call will be ignored and logged as missed call in the caller ID log.
- The screening feature of Smart call blocker is applicable to home calls only.

Answer an incoming cell call while on a home call

If you are on a home call and you receive an incoming cell call, you hear a beep and **📶** displays on the handset. All other handsets ring.

- To answer the incoming cell call, Press **📶 CELL**. The home call is automatically placed on hold.
- To end the cell call, press **OFF/CANCEL**. The home line is still on hold.
- To resume the home call on hold, press **🏠 HOME/FLASH**.

Answer an incoming home call while on a cell call

If you are on a cell call and you receive an incoming home call, you hear a beep and **🏠** displays on the handset. All other handsets ring.

- To answer the incoming home call, Press **🏠 HOME/FLASH**. The cell call is automatically placed on hold.
- To end the home call, press **OFF/CANCEL**. The cell line is still on hold.
- To resume the cell call on hold, press **📶 CELL**.

Intercom

Use the intercom feature for conversations between two devices.

NOTES

- Your telephone base supports up to five handsets. You can buy additional expansion handsets (**LS6300**) for this telephone base.
- You can use four devices on two pairs of intercom calls. For example, when four handsets are used on two pairs of intercom calls, use the fifth handset for an outside call.

Initiate an intercom call with a cordless handset

1. Press **MENU/SELECT** in idle mode to enter the main menu.
2. Press **▼CID** or **▲** to highlight **Intercom**, then press **MENU/SELECT**.
 - If you have two or more handsets, your handset shows **Intercom to:**. Press **1-5** for **HANDSET 1** to **HANDSET 5**. Your handset shows **Calling HS X**. The destination handset rings and shows **HS X is calling**.

3. To answer the intercom call, press **HOME/FLASH**, **CELL** or **Speaker** on the destination handset. Both handsets now display **Intercom**.

4. To end the intercom call on either handset, one party presses **OFF/CANCEL**, or places the handset back in the handset charger.

NOTES

- To cancel the intercom call before it is answered, press **OFF/CANCEL**.
- Press **OFF/CANCEL** or **MUTE/DELETE** on the cordless handset to temporarily silence the intercom ringer.
- If the destination handset does not answer the intercom call within 100 seconds, is accessing the answering system, on a call or out of range, the originating handset displays **Unable to call** and returns to idle mode.
- If there is an incoming call while the originating handset displays **Calling HS X**, the intercom request will be stopped and the screen displays **Incoming call**.

Answer an incoming home call during an intercom call

If you receive an incoming home call during an intercom call, there is an alert tone. Handsets flash **HOME/FLASH** and display the caller ID.

To answer an outside home call during an incoming call:

- Press **HOME/FLASH** on the cordless handset, the intercom call ends automatically.
- Press **OFF/CANCEL** to end the intercom call. The telephone continues to ring. Then, press **HOME/FLASH**.
- To end the intercom call without answering the outside call, press **OFF/CANCEL**. The intercom call ends and the telephone continues to ring.

Transfer a call via intercom

Use the intercom feature to transfer an outside call to another system handset.

1. During a call, press **MENU/SELECT**.
 - If you have two or more handsets, your handset displays **Intercom to:**. Press **1-5** for **HANDSET 1** to **HANDSET 5**. The outside call is put on hold and your handset displays **Calling HS X**.
The destination handset rings and its screen displays **HS X is calling**.
2. To answer the intercom call on the destination handset, press **HOME/FLASH**, **CELL** or **Speaker** on the destination handset. The outside call is still on hold and both handsets now display **Intercom**. You can now have a private conversation with the destination handset.
3. For this intercom call, you have the following options:
 - You can let the destination handset join you on the outside call in a three-way conversation. Press **HOME/FLASH** on the originating or destination handset.
 - You can transfer the call. Press **OFF/CANCEL**, or place your handset back in the handset charger. Your handset displays **Line in use**. The destination handset is then connected to the outside call.

- The called party can end the intercom call by pressing **OFF/CANCEL**, or by placing the other handset back in the telephone base or charger. The outside call continues with the originating handset.

Find handset

Page/ find handset

⚠ CAUTIONS

- Do not press and hold **FIND HS** for more than four seconds. It may lead to handset deregistration.
- If the handset displays **To register HS...** and **...see manual**, refer to **Add and register handset** section to register the handset back to the telephone base.

This feature helps you find all system handsets.

To start paging:

- Press **FIND HS** on the telephone base when it is not in use. All idle handsets ring and display **** Paging ****.

To end paging:

- Press **FIND HS** again on the telephone base.

-OR-

- Press **HOME/FLASH**, **CELL**, **OFF/CANCEL**, or any dialing keys on the handset.

-OR-

- Place the handset in the handset charger.

📄 NOTES

- If you press **MUTE/DELETE** on a handset, the ringer of that handset is silenced but the paging tone continues on the other handsets.
- If a handset is accessing the answering system, on a call (intercom call or outside call), or out of range, that handset does not beep when paged.
- You cannot use the find handset feature while the telephone base is playing messages or the answering system is being accessed remotely.

Use phone menu

- Press **MENU/SELECT** in idle mode (when the telephone is not in use) to enter the main menu.
- Press **▼ CID** or **▲** to scroll through menu items.
- Press **MENU/SELECT** to select or save the highlighted item.

-OR-

Press **OFF/CANCEL** to cancel an operation, back up to the previous menu, or press and hold to exit the menu display completely.

Phonebook

Phonebook | Phonebook entry

The phonebook can store up to 1,000 entries, which are shared by all handsets. Each entry may consist of a telephone number up to 30 digits, and a name up to 15 characters.



Any additions, deletions or edits made on one handset will be reflected on other handsets.

If the telephone number in the phonebook exceeds 15 digits, a dash appears after the 14th digit and then the remaining digits are shown beginning with a dash, alternately.

NOTES

- Only one handset can review the phonebook at a time. If another handset tries to enter the phonebook, its screen shows **Not available**.
- When there are no records in the phonebook, the screen shows **List empty**.
- When you try to save a number already stored in the phonebook, the screen shows **Number repeated**.
- When Smart call blocker is on, calls with numbers saved in the phonebook will get through and ring on your telephone. If a number saved in the phonebook is also saved in the block list, calls from this number will be blocked.





Add a phonebook entry

1. Enter the number when the phone is not in use. Press **MENU/SELECT**, then go to Step 3.
-OR-
Press **MENU/SELECT** when the telephone is not in use.
2. Press **▼ CID** or **▲**  to highlight **Phonebook**, and then press **MENU/SELECT**.
3. Press **MENU/SELECT** again to choose **Add new entry**.
4. The screen shows **Enter number**. Use the dialing keys to enter a telephone number (up to 30 digits).
 - Press **▼ CID** or **▲**  to move the cursor to the left or right.
 - Press **MUTE/DELETE** to erase a digit.
 - Press and hold **MUTE/DELETE** to erase all digits.
 - Press and hold **REDIAL/PAUSE** to insert a three-second dialing pause (a **P** appears).**-OR-**
Press **REDIAL/PAUSE** to copy a number from the redial list. Press **▼ CID** or **▲** , or press **REDIAL/PAUSE** repeatedly to locate the desired number. Press **MENU/SELECT** to copy the displayed number.
5. Press **MENU/SELECT** to proceed to entering name.
 - The screen shows **Enter name**.
6. Use the dialing keys to enter a name

(up to 15 characters) when prompted.

- Press a key repeatedly until the desired character shows on the screen.
 - Press **▼ CID** or **▲**  to move the cursor to the left or right.
 - Press **0** to add a space.
 - Press **MUTE/DELETE** to erase a character.
 - Press and hold **MUTE/DELETE** to erase all characters.
 - Press **0** to add a space (for entering names only).
 - Press **-tone X** to change the next letter to upper or lower case.
7. Press **MENU/SELECT** to store your new phonebook entry.

Review the phonebook entries

1. Press **▲**  when the telephone is not in use.
 - The screen displays the first entry in the phonebook.
2. Press **▼ CID** or **▲**  to browse through the phonebook or use the dialing keys to start a name search.
-OR-
 1. Press **MENU/SELECT** when in idle mode.
 2. Press **▼ CID** or **▲**  to scroll to **Phonebook**, then press **MENU/SELECT**.
 3. Press **▼ CID** or **▲**  to scroll to **Review**, then press **MENU/SELECT**.
 - The screen shows the first entry in the phonebook.
 4. Press **▼ CID** or **▲**  to scroll to browse through the phonebook.
 - Entries appear alphabetically by the first letter in the name.

Dial a phonebook entry

You can dial a phonebook entry on either a home or cell line.

1. Search for the desired entry in the phonebook (see **Review the phonebook entries** or **Alphabetical search**).
2. When the displayed number is in the correct format: Press **HOME/FLASH** or **CELL** to dial with the home line.
-OR-
Press **CELL** to dial with the cell line.

Edit a phonebook entry

1. While reviewing a phonebook entry, press **MENU/SELECT**.
2. Use the dialing keys to edit the number, and then press **MENU/SELECT**.
3. Use the dialing keys to edit the name, and then press **MENU/SELECT** to save. You hear a confirmation tone.

Delete a phonebook entry

1. While reviewing a phonebook entry (see **Review the phonebook entries** or **Alphabetical search**), press **MUTE/DELETE**.
 - The screen shows **Delete entry?**.
2. Press **MENU/SELECT** to delete the displayed entry from the phonebook.
 - The handset shows **Deleting...** and then you hear a confirmation tone.

NOTE

- Once deleted, you cannot retrieve that entry.

Delete all phonebook entries

1. Press **MENU/SELECT** when in idle mode.
2. Press **▼ CID** or **▲** to scroll to **Phonebook**, then press **MENU/SELECT**.
3. Press **▼ CID** or **▲** to scroll to **Delete all**, then press **MENU/SELECT**.
4. The handset shows **Delete all?**. Press **MENU/SELECT** to confirm. The handset shows **Deleting....** You hear a confirmation tone.

Alphabetical search

You can use the enhanced 3-character search to find your contacts quickly and efficiently.

1. Press **▲** when the handset is in idle mode.
2. When an entry appears, use the dialing keys (**0-9**) to start a name search (alphabetical search).
 - The phonebook shows the first name beginning with the first letter associated with the dialing key, i.e. if there is an entry in the phonebook that begins with that letter.
 - Press **▼ CID** or **▲** to scroll through the entries beginning with that letter.
3. To see other names that start with the letters on the same dialing key, keep pressing the key until the desired letter is shown.
 - The names appear in alphabetical order.

For example, if you have the names Jennifer, Jessie, Kevin and Linda in your phonebook:

- If you press **5 (JKL)** once, **J** and then Jennifer displays.
- If you press **5 (JKL)** once, **J** displays. Press **▼**. **Jessie** displays.
- If you press **5 (JKL)** twice, **K** and then **Kevin** displays.

- If you press **5 (JKL)** three times, **L** and then **Linda** displays.
- If you press **5 (JKL)** four times, **5** displays.
- If you press **5 (JKL)** five times, **J** displays and then **Jennifer** displays again.

NOTE

- If you press a dialing key (**0-9**) and no name starts with any letter on that key, the phonebook shows the entry that matches the next letter in the phonebook.

Redial list

Each handset stores the last 10 telephone numbers dialed. Entries are shown in reverse chronological order. When there are already 10 entries, the oldest entry is deleted to make room for the new entry.

Review a redial list entry

1. Press **REDIAL/PAUSE** in idle mode.
2. Press ▲📖, ▼ **CID** or **REDIAL/PAUSE** repeatedly to browse until the desired number displays. The handset beeps twice at the end of the list.
3. Press **OFF/CANCEL** to exit.

Dial a redial list entry

1. Press **REDIAL/PAUSE** to enter the redial list.
2. Press ▲📖, ▼ **CID** or **REDIAL/PAUSE** repeatedly to browse until the desired entry displays.
3. Press 🏠 **HOME/FLASH** or 📞 to dial using the home line, or press 📶 **CELL** to dial using the cell line.

-OR-

1. Press 🏠 **HOME/FLASH** or 📞 to take the home line, or press 📶 **CELL** to take the cell line.
2. Press **REDIAL/PAUSE** to enter the redial list.

3. Press ▲📖, ▼ **CID** or **REDIAL/PAUSE** repeatedly to browse until the desired entry displays.
4. Press **MENU/SELECT** to dial the displayed number.

Save a redial entry to the phonebook

1. Press **REDIAL/PAUSE** in idle mode.
2. Press ▲📖, ▼ **CID** or **REDIAL/PAUSE** repeatedly to browse until the desired number displays.
3. Press **MENU/SELECT** twice.
4. The screen displays **Enter number**. Use the dialing keys to edit the number, if necessary.
 - Press ▼ **CID** or ▲📖 to move the cursor to the left or right.
 - Press **MUTE/DELETE** to erase a digit.
 - Press and hold MUTE/DELETE to erase all digits.
 - Press and hold REDIAL/PAUSE to insert a three-second dialing pause (a **P** appears).
5. Press **MENU/SELECT**.
6. The screen displays **Enter name**. Use the dialing keys to enter a name (up to 15 characters). Press a key repeatedly until the desired character shows on the screen.
 - Press ▼ **CID** or ▲📖 to move the cursor to the left or right.

- Press **0** to add a space.
 - Press **MUTE/DELETE** to erase a character.
 - Press and hold MUTE/DELETE to erase all characters.
 - Press **-tone X** to change the next letter to upper or lower case.
7. Press **MENU/SELECT**. You hear a confirmation tone.

Delete a redial list entry

1. Press **REDIAL/PAUSE** in idle mode.
2. Press ▲📖, ▼ **CID** or **REDIAL/PAUSE** repeatedly to browse until the desired number displays.
3. Press **MUTE/DELETE** to delete the displayed number.
 - You hear a confirmation tone.

Chain dialing

Use this feature to initiate a dialing sequence from numbers stored in the phonebook, caller ID log or redial list while you are on a call.

Chain dialing is useful if you wish to access other numbers (such as bank account numbers or access codes) from the phonebook, caller ID log or redial list.

Access a number in the phonebook while on a call

1. Press **MENU/SELECT**.
2. Press **MENU/SELECT** to select **Phonebook**.
3. Press ▼ **CID** or ▲📖 to scroll to the desired entry or perform an alphabetical search, then press **MENU/SELECT** to dial the displayed number.

Access a number in the caller ID log while on a call

1. Press **MENU/SELECT**.
2. Press ▼ **CID** or ▲📖 to scroll to **Caller ID log**, then press **MENU/SELECT**.
3. Press ▼ **CID** or ▲📖 to scroll to the desired entry, and then press **MENU/SELECT** to dial the displayed number.

Access the redial list while on a call

1. Press **REDIAL/PAUSE**.
2. Press **▲** , **▼ CID** or **REDIAL/PAUSE** until the desired number displays.
3. Press **MENU/SELECT** to dial the displayed number.

NOTES

- You cannot edit a phonebook entry while on a call.
- You cannot copy a caller ID log entry into the phonebook while on a call.
- You can only view the numbers in the phonebook, caller ID log or redial list while on a call and cannot edit, delete or save entries.
- Press **OFF/CANCEL** to exit redial list, phonebook or caller ID log while on a call.

Caller ID

If you subscribe to caller ID service, information about each caller appears after the first or second ring. If you answer a call before the caller information appears on the screen, it will not be saved in the caller ID log.

The caller ID log stores up to 50 entries. Each entry has up to 24 digits for the phone number and 15 characters for the name.

If the telephone number has more than 15 digits, only the last 15 digits appear.

If the name has more than 15 characters, only the first 15 characters are shown and saved in the caller ID log.

Entries appear in reverse chronological order. When the caller ID log is full, the oldest entry is deleted to make room for new incoming call information.

Caller ID log entries are shared by all system handsets (for multiple handset models only). Any deletions made on one handset are reflected on all other handsets.

Review the caller ID log

Review the caller ID log to find out who called, to return the call or to copy the caller's name and number into your phonebook.



1. When the telephone is not in use, press **▼ CID** to view the caller ID log in reverse chronological order starting with the most recent call.

-OR-

You can also review the caller ID log by pressing **MENU/SELECT** when the telephone is not in use, then press **▼ CID** or **▲**  to scroll to **Caller ID log**. Press **MENU/SELECT** twice to select **Review**.

2. Press **▼ CID** or **▲**  to scroll through the list. You hear two beeps when you reach the beginning or end of the caller ID log.
3. Press **OFF/CANCEL** to exit the caller ID log.

Save a caller ID log entry to the phonebook



1. While reviewing the caller ID log, press **▼ CID** or **▲**  to browse through the caller ID log.
2. When the desired entry displays, press **MENU/SELECT**.
3. Press **MENU/SELECT** again to choose **To Phonebook**.
4. When the screen shows **Enter number**, use the dialing keys to modify the telephone number (up to 30 digits).
 - Press **▼ CID** or **▲**  to move the cursor to the left or right.
 - Press and hold **REDIAL/PAUSE** to enter a 3-second dialing pause (a **P** appears).
 - Press **MUTE/DELETE** to erase a digit.
 - Press and hold **MUTE/DELETE** to erase all digits.
5. Press **MENU/SELECT** to save the number in the display.
 - The screen shows **Enter name**.
6. Use the dialing keys to modify the name (up to 15 characters).
 - Press **0** to add a space.
 - Press **▼ CID** or **▲**  to move the cursor to the left or right.
 - Press **MUTE/DELETE** to erase a character.
 - Press and hold **MUTE/DELETE** to erase all characters.

- Press **TONE X** to change the next letter to upper or lower case.
7. Press **MENU/SELECT** to save.
- You hear a confirmation tone.



NOTES

- If a number is already in the phonebook. You cannot save the same number more than once.
- If you try to save a caller ID log entry to the phonebook without a number, the handset sounds an error tone.
- If the telephone number has more than 15 digits, only the last 15 digits appear in the caller ID log. However, the telephone can still save all digits (up to 24 digits) of that telephone number from the caller ID log in the phonebook.
- You might need to change how a caller ID number is saved in the phonebook if the entry does not appear in the correct format. Caller ID numbers might appear with an area code that is not necessary for local calls, or without a 1 that is necessary for long distance calls.
- Caller ID log entries are shared by all system handsets. Any deletions made on one handset are reflected on all other handsets.

Save a caller ID log entry to allow list

1. Search for the desired caller ID log entry (see **Review the caller ID log**).
2. When the desired entry displays, press **MENU/SELECT**.
3. Press **▼ CID** or **▲**  to scroll to **To Allow list**, then press **MENU/SELECT**.
4. The screen displays **Enter number**. Use the dialing keys to edit the number, when necessary.
 - Press **▼ CID** or **▲**  to move the cursor to the left or right.
 - Press **MUTE/DELETE** to backspace and erase a digit.
 - Press and hold **MUTE/DELETE** to erase the entire entry.
 - Press and hold **REDIAL/PAUSE** to enter a 3-second dialing pause (a **P** appears).
5. Press **MENU/SELECT** to move to the name.
 - The screen shows **Enter name**.
6. Use the dialing keys to add or edit the name.
 - Press **▼ CID** or **▲**  to move the cursor to the left or right.
 - Press **0** to add a space.
 - Press **MUTE/DELETE** to erase a character.
 - Press and hold **MUTE/DELETE** to erase all characters.
 - Press **TONE X** to change the next letter to upper or lower case.
7. Press **MENU/SELECT** to save.



Save a caller ID log entry to block list

1. Search for the desired caller ID log entry (see **Review the caller ID log**).
2. When the desired entry displays, press **MENU/SELECT**.
3. Press **▼ CID** or **▲**  to scroll to **To Block list**, then press **MENU/SELECT**.
4. The screen displays **Enter number**. Use the dialing keys to edit the number, when necessary.
 - Press **▼ CID** or **▲**  to move the cursor to the left or right.
 - Press **MUTE/DELETE** to backspace and erase a digit.
 - Press and hold **MUTE/DELETE** to erase the entire entry.
 - Press and hold **REDIAL/PAUSE** to enter a 3-second dialing pause (a **P** appears).
5. Press **MENU/SELECT** to move to the name.
 - The screen shows **Enter name**.
6. Use the dialing keys to add or edit the name.
 - Press **▼ CID** or **▲**  to move the cursor to the left or right.
 - Press **0** to add a space.
 - Press **MUTE/DELETE** to erase a character.
 - Press and hold **MUTE/DELETE** to erase all characters.
 - Press **TONE X** to change the next letter to upper or lower case.
7. Press **MENU/SELECT** to save.

Save a caller ID log entry to star name list

1. Search for the desired caller ID log entry (see **Review the caller ID log**).
2. When the desired entry displays, press **MENU/SELECT**.
3. Press **▼ CID** or **▲**  to scroll to **To Star name**, then press **MENU/SELECT**.
4. The screen displays **Star the name?**. Press **MENU/SELECT** to confirm.

Dial a caller ID log entry



1. Search for the desired entry in the caller ID log (see **Review the caller ID log**).
2. When the desired entry is displayed and is in the correct format for dialing:
 - Press **HOME/FLASH** or  to dial using the home line.
 - OR-**
 - Press  **CELL** to dial using the cell line.

Delete caller ID log entries

To delete an entry:

1. Search for the desired entry in the caller ID log (see **Review the caller ID log**).
2. When the desired entry is displayed, press **MUTE/DELETE**. The screen displays **Deleting...**. Then you hear a confirmation tone.

To delete all entries:

1. Press **MENU/SELECT** when the telephone is not in use.
2. Press **▼ CID** or **▲**  to highlight **Caller ID log**, then press **MENU/SELECT**.
3. Press **▼ CID** or **▲**  to highlight **Delete all**, then press **MENU/SELECT**.
4. When the screen shows **Delete all?**, press **MENU/SELECT** to confirm.
 - There is a confirmation tone and the screen returns to the previous menu.

Caller ID memory match

If the incoming telephone number matches the last 7 digits of a telephone number in your phonebook, the name that appears on the screen matches the corresponding name in your phonebook.

For example, if **Christine Smith** calls, her name appears as **Chris** if this is how you entered it into your phonebook.

NOTE

- The number you see on your caller ID is in the format sent by the telephone service provider. It usually delivers 10-digit telephone numbers (area code plus telephone number). If the last 7 digits of the incoming telephone number do not match a number in your phonebook, the name appears as it is delivered by the telephone service provider.

Missed call indicator

When a cordless handset or the telephone base is in idle mode and has new or missed calls, its screen shows **XX Missed calls**.

All new and missed entries are counted as missed calls. Each time you review a new caller ID log entry (indicated by  on the screen), the missed calls message goes away. When there is a new unanswered call, the missed calls message displays again. The number of missed calls includes all new and missed entries that have not been reviewed.

If you do not want to review the missed calls one by one, but still want to keep them in the caller ID log, you can press and hold **OFF/CANCEL** for four seconds when the handset is idle.

- You will hear a confirmation tone.
- All the entries in the caller ID log become old (reviewed already).
- Missed calls message disappears.

Smart call blocker*§

If you have subscribed to caller ID service, then you can use Smart call blocker to screen incoming calls.

Smart call blocker is an effective call screening tool, which allows your phone system to screen **ALL** home calls.

The screening feature of Smart call blocker is applicable to home calls only. All incoming cell calls will get through and ring. If you want to block a cell call, add the number to the block list. Read on and learn how to change to call screening mode †, add the number to the block list, and perform the necessary preparations before use.

- † With Call screening active, Smart Call Blocker screens and filters all incoming home calls from numbers or names that are not saved in your phonebook, allow list, block list, or star name list. You can easily add incoming phone numbers to your allow list and block list. This allows you to build up your lists of allowed and blocked numbers, and Smart Call Blocker will know how to handle these calls when they call again.

* Use of Smart call blocker feature requires subscription of caller ID service.

§ Includes licenced Qaltel™ technology. Qaltel™ is a trademark of Truecall Group Limited.

Smart call blocker filters robocalls and unwanted calls for you, while allowing welcome calls to get through.

You can set up your lists of welcome callers and unwelcome callers. Smart call blocker allows calls from your welcome callers to get through, and it blocks calls from your unwelcome callers.

For other unknown home calls, you can block, screen, or forward these calls to the answering system.

With some easy configurations, you can set to only filter robocalls on the home line by asking the callers to press the pound key (#) before the calls are put through to you.

You can also set the Smart call blocker to screen home calls by asking the callers to record their names and press the pound key (#). After your caller completes the request, your telephone rings and announces the caller's name. You can then choose to block or answer the call, or you can forward the call to the answering system.

If the caller hangs up, or does not respond or record his/her name, the call is blocked from ringing through.

When you add your welcome callers to your Phonebook or Allow list, they will bypass all screening and ring directly to your handsets.

NOTES

- Smart call blocker is on, once you install your telephone. It allows all incoming calls to get through and ring by default. You can change the Smart call blocker settings to screen incoming home calls. For more details, see **Set profile**.
- To turn off Smart call blocker, see **Set Smart call blocker on/off**.

Overview

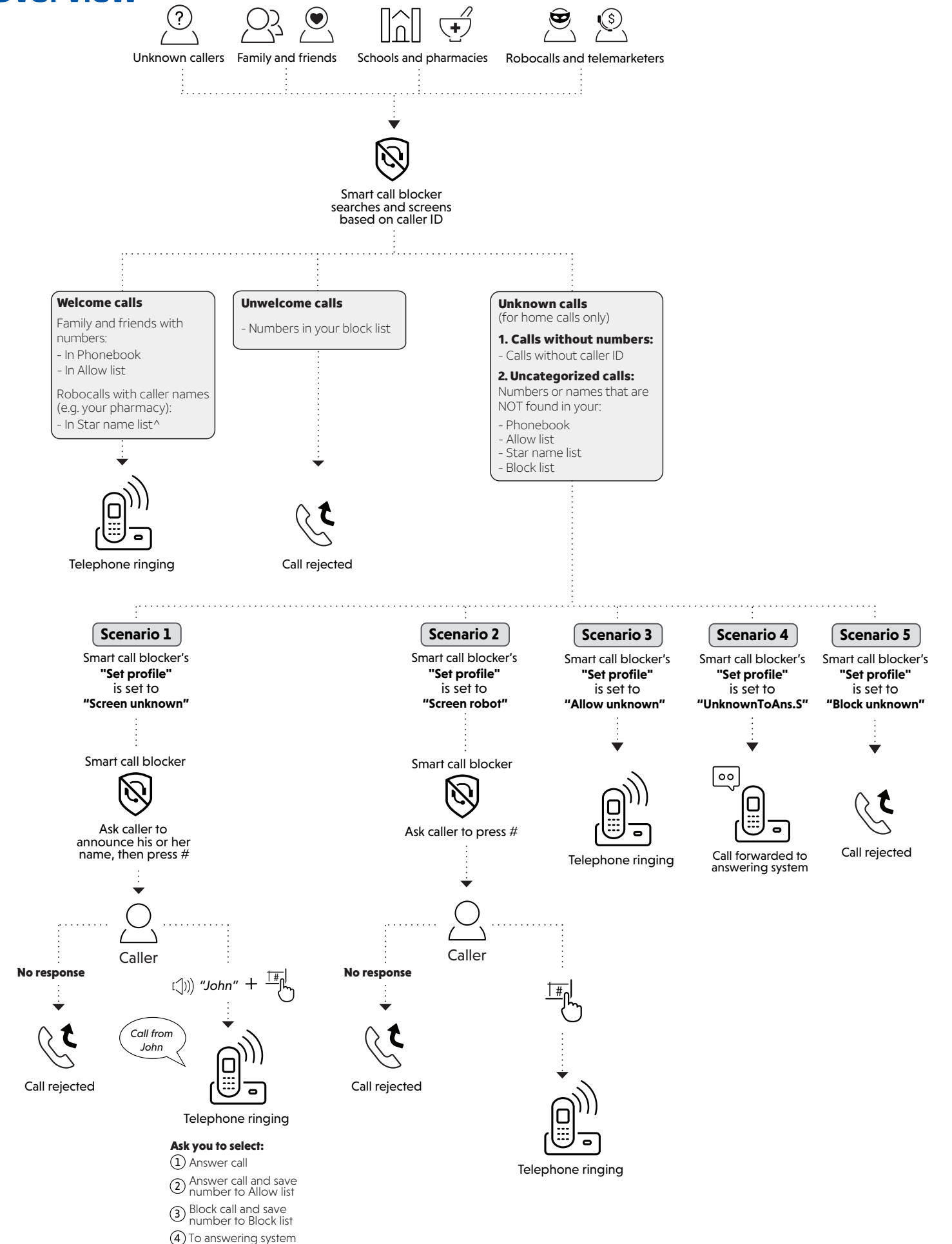

Call categories

Calls are classified into four categories:

Welcome calls

Welcome calls are calls with telephone numbers saved in your allow list or phonebook, and not in your block list.

Welcome calls also include calls with caller names saved in your star name list.

NOTE

- There are many organizations like schools, medical offices, and pharmacies that use robocalls to communicate important information to you. Robocall uses an autodialer to deliver pre-recorded messages. By entering the **EXACT** Caller ID (CID)'s name of the organizations into the star name list, it ensures these calls will ring through when you only know the caller names but not their numbers. See [Star name list](#).

Unwelcome calls

Unwelcome calls are calls with telephone numbers saved in your block list, and you want to block their calls.

Calls without numbers (for home calls only)

Calls without numbers are calls that are "out of area" or with numbers set to "Private".

Uncategorized calls (for home calls only)

Uncategorized calls include calls with absent caller ID number, calls with numbers that are not in your phonebook, allow list, or block list, or calls with caller ID names that are not in your star name list.

NOTE

- The allow list stores up to 200 entries, the block list stores up to 1,000 entries, and the star name list stores up to 10 names.

Call handling

- Smart call blocker is set to on, and to allow all incoming home calls by default. When Smart call blocker is on, the first ring of all incoming calls will be muted.
- If your phonebook, allow list, star name list and block list are empty when Smart call blocker is on, and you have set to screen calls, the telephone will screen all incoming home calls and asks callers to announce their names or press the pound key (#).
- If Smart call blocker is off, all incoming home and cell calls ring, including numbers saved in the block list.
- If QUIET mode is on, and Smart call blocker is on and in screening mode, all screened home calls will be sent to the answering system after screening.



Smart call blocker handles calls in the following ways:

Call category		Call handling / Set profile options
Welcome calls	<ul style="list-style-type: none">• Numbers saved in allow list.• Numbers saved in phonebook.• Numbers not found in block list.• Caller ID names saved in star name list.	<ul style="list-style-type: none">• The telephone rings when there is an incoming home call with number saved in your allow list or phonebook, but not in your block list. Robocalls with caller names saved in your star name list will also ring.• All incoming calls on your cell line will get through and ring.
Unwelcome calls	<ul style="list-style-type: none">• Numbers saved in block list.	<ul style="list-style-type: none">• The telephone does not ring when there is an incoming call with number saved in your block list, and the call will be rejected.

Call category		Call handling / Set profile options
Unknown calls (for home calls only)	<ul style="list-style-type: none"> · Calls without numbers · Numbers that are "out of area" or set to "Private". · With absent caller ID number. 	<p>You can select one of the following five profile options for handling all unknown home calls.</p> <p>Screen unknown The telephone plays the screening announcement, and then ask the caller to say his/her name before the call rings on your telephone. You can then answer the call, and hear the caller's name announced. You can decide whether to accept or reject the call, or to forward the call to the answering system.</p> <p>Screen robot The telephone plays the screening announcement, and then ask the caller to press the pound key (#) before the call rings on your telephone. You can then answer the call.</p> <p>Allow unknown (default settings) The telephone allows these calls to get through and ring. The caller's number, even if it is available, will not be saved to the allow list.</p> <p>Unknown to answering system The telephone forwards these calls to the answering system without ringing.</p> <p>Block unknown The telephone rejects these calls with block announcement without ringing. The caller's number, even if it's available, will not be saved to the block list.</p>
	<ul style="list-style-type: none"> · Uncategorized calls · Numbers not found in directory. · Numbers not found in allow list. · Numbers not found in block list. · With caller ID names not found in star name list 	

Set Smart call blocker on/off

The Smart call blocker feature is set to on by default.



1. Press **CALL BLOCK** when the handset is not in use.
-OR-
Press **MENU/SELECT** when the handset is not in use to enter the main menu. Then, press ▼ **CID** or ▲  to scroll to **Smart call blk** and then press **MENU/SELECT**.
2. Press **MENU/SELECT** again to select **SCB On/Off**.
3. Press ▼ **CID** or ▲  to choose **On** or **Off**, then press **MENU/SELECT** to save the setting. You hear a confirmation tone.

NOTE

- If you set **SCB On/Off** to **Off**, all settings under **Set profile** (see below) will be invalid.

Set profile

There are five profile setting options, which allows you to quickly set up Smart call blocker.

1. Press **CALL BLOCK** when the handset is not in use.
-OR-
Press **MENU/SELECT** when the handset is not in use to enter the main menu. Then, press ▼ **CID** or ▲  to scroll to **Smart call blk** and then press **MENU/SELECT**.
2. Press ▼ **CID** or ▲  to scroll to **Set profile**, then press **MENU/SELECT**.
3. Press ▼ **CID** or ▲  to select one of the following options, then press **MENU/SELECT**.
 - **Screen unknown** - screen any home calls without numbers or with numbers not saved in the phonebook, allow list, or star name list.
 - This profile setting sets the telephone to screen all unknown home calls and asks the callers to say their names before putting the calls through to you. See **Screen unknown home calls**.

- **Screen robot** - screen robocalls.
 - This profile setting sets the telephone to screen all unknown home calls and asks the callers to press the pound key (#) before putting the calls through to you. See **Screen robocalls**.
- **Allow unknown** (default setting)
 - allow all unknown home calls to ring, except calls with numbers saved in the block list.
 - This profile setting sets the telephone to allow all unknown home calls to get through and ring. Calls with numbers saved in the block list will be rejected.
- **UnknownToAns.S** - forward all unknown home calls to the answering system.
 - This profile setting sets the telephone to forward all unknown home calls to the answering system.
- **Block unknown** - block all unknown home calls.
 - This profile setting sets the telephone to block all unknown home calls.

After selecting a profile setting, make sure you have not turned off Smart call blocker. Refer to the **Set Smart call blocker on/off** section to turn it on.





Block list

Add numbers that you want to prevent their calls from ringing through. The block list stores up to 1,000 entries.

NOTE

- Home or cell calls with numbers that have been added to your block list will be blocked.

Add a block entry

1. Press **CALL BLOCK** when the handset is not in use.
 - OR- Press **MENU/SELECT** when the handset is not in use to enter the main menu. Then, press **▼ CID** or **▲**  to scroll to **Smart call blk** and then press **MENU/SELECT**.
2. Press **▼ CID** or **▲**  to select **Block list** and then press **MENU/SELECT**.
3. Press **▼ CID** or **▲**  to select **Add new entry**, then press **MENU/SELECT**.
4. When **Enter number** displays, use the dialing keys to enter the number.
 - OR- Copy a number from the redial list by pressing **REDIAL/PAUSE** and then press **▲** , **▼ CID** or **REDIAL/PAUSE** repeatedly to select a number. Press **MENU/SELECT** to copy the number.

5. Press **MENU/SELECT** to move on to enter the name. The handset displays **Enter name**.
6. Use the dialing keys to enter the name. Additional key presses show other characters of that particular key. The first character of every word is capitalized.
7. Press **MENU/SELECT** to save. You hear a confirmation tone.



While entering names and numbers, you can:

- Press **MUTE/DELETE** to backspace and erase a digit or character.
- Press and hold **MUTE/DELETE** to erase the entire entry.
- Press **▼ CID** or **▲**  to move the cursor to the left or right.
- Press and hold **REDIAL/PAUSE** to insert a dialing pause (for entering numbers only).
- Press **0** to add a space (for entering names only).
- Press **TONE X** to change the next letter to upper or lower case.



NOTES

- Numbers saved in your phonebook can also be saved to the block list.
- If you save a block entry that has already been saved to the allow list, the entry in the allow list will be removed.

Review block list entries

1. Press **CALL BLOCK** when the handset is not in use.
 - OR- Press **MENU/SELECT** when the handset is not in use to enter the main menu. Then, press **▼ CID** or **▲**  to scroll to **Smart call blk** and then press **MENU/SELECT**.
2. Press **▼ CID** or **▲**  to select **Block list** and then press **MENU/SELECT**.
3. Press **MENU/SELECT** to choose **Review**.
4. Press **▼ CID** or **▲**  to browse through the block list.



Save a caller ID log entry to block list

1. Search for the desired caller ID log entry (see **Review the caller ID log**).
2. When the desired entry displays, press **MENU/SELECT**.
3. Press **▼ CID** or **▲**  to scroll to **To Block list**, then press **MENU/SELECT**.
4. The screen displays **Enter number**. Use the dialing keys to edit the number, when necessary.
 - Press **▼ CID** or **▲**  to move the cursor to the left or right.
 - Press **MUTE/DELETE** to backspace and erase a digit.
 - Press and hold **MUTE/DELETE** to erase the entire entry.
 - Press and hold **REDIAL/PAUSE** to enter a 3-second dialing pause (a **P** appears).
5. Press **MENU/SELECT** to move to the name.
 - The screen shows **Enter name**.
6. Use the dialing keys to add or edit the name.
 - Press **▼ CID** or **▲**  to move the cursor to the left or right.
 - Press **0** to add a space.
 - Press **MUTE/DELETE** to erase a character.
 - Press and hold **MUTE/DELETE** to erase all characters.
 - Press **tone X** to change the next letter to upper or lower case.
7. Press **MENU/SELECT** to save.



Edit a block list entry

1. Search for the desired entry in the call block list (see **Review block list entries**).
2. When the desired entry appears, press **MENU/SELECT**. The handset displays **Enter number** and the stored number.
3. Use the dialing keys to edit the number, then press **MENU/SELECT**. The handset displays **Enter name** and then the stored name.
4. Use the dialing keys to edit the name. Additional key presses show other characters of that particular key. The first character of every word is capitalized.
5. Press **MENU/SELECT** to save. You hear a confirmation tone.

Unblock a telephone number

1. Search for the desired entry in the call block list (see **Review block list entries**).
 2. When the desired call block list entry displays, press **MUTE/DELETE**. The screen shows **Delete entry?**.
 3. Press **MENU/SELECT** to confirm. The screen show **Deleting...** You hear a confirmation tone. You cannot retrieve a deleted entry.
- OR -**
1. Press **CALL BLOCK** when the handset is not in use.
- OR-**
- Press **MENU/SELECT** when the handset is not in use to enter the main menu. Then, press **▼ CID** or **▲**  to scroll to **Smart call blk** and then press **MENU/SELECT**.
2. Press **▼ CID** or **▲**  to select **Block list** and then press **MENU/SELECT**.
 3. Press **MENU/SELECT** to choose **Review**.
 4. Press **▼ CID** or **▲**  to browse through the block list.
 5. When the desired call block list entry displays, press **MUTE/DELETE**. The screen shows **Delete entry?**.
 6. Press **MENU/SELECT** to confirm. The screen show **Deleting...** You hear a confirmation tone. You cannot retrieve a deleted entry.

Delete all block list entries

1. Press **CALL BLOCK** when the handset is not in use.
 - OR-**
 - Press **MENU/SELECT** when the handset is not in use to enter the main menu. Then, press **▼ CID** or **▲**  to scroll to **Smart call blk** and then press **MENU/SELECT**.
2. Press **▼ CID** or **▲**  to select **Block list** and then press **MENU/SELECT**.
3. Press **▼ CID** or **▲**  to select **Delete all**, and then press **MENU/SELECT**. The screen shows **Delete all?**.
4. Press **MENU/SELECT** again to confirm. The screen displays **Deleting...** There is a confirmation tone.

Allow list

Add numbers that you want to allow their calls to get through to you. The allow list stores up to 200 entries.

Add an allow list entry

1. Press **CALL BLOCK** when the handset is not in use.
-OR-
Press **MENU/SELECT** when the handset is not in use to enter the main menu. Then, press **▼ CID** or **▲** to scroll to **Smart call blk** and then press **MENU/SELECT**.
2. Press **▼ CID** or **▲** to select **Allow list** and then press **MENU/SELECT**.
3. Press **▼ CID** or **▲** to select **Add new entry**, then press **MENU/SELECT**.
4. When **Enter number** displays, use the dialing keys to enter the number.
-OR-
Copy a number from the redial list by pressing **REDIAL/PAUSE** and then press **▲**, **▼ CID** or **REDIAL/PAUSE** repeatedly to select a number. Press **MENU/SELECT** to copy the number.
5. Press **MENU/SELECT** to move on to enter the name. The handset displays **Enter name**.

6. Use the dialing keys to enter the name. Additional key presses show other characters of that particular key. The first character of every word is capitalized.
7. Press **MENU/SELECT** to save. You hear a confirmation tone.

While entering names and numbers, you can:

- Press **MUTE/DELETE** to backspace and erase a digit or character.
- Press and hold **MUTE/DELETE** to erase the entire entry.
- Press **▼ CID** or **▲** to move the cursor to the left or right.
- Press and hold **REDIAL/PAUSE** to insert a dialing pause (for entering numbers only).
- Press **0** to add a space (for entering names only).
- Press **TONE ✕** to change the next letter to upper or lower case.

NOTES

- Numbers saved in your phonebook can also be saved to the allow list.
- If you save an allow list entry that has already been saved to the block list, the entry in the block list will be removed.

Review allow list entries

1. Press **CALL BLOCK** when the handset is not in use.
-OR-
Press **MENU/SELECT** when the handset is not in use to enter the main menu. Then, press **▼ CID** or **▲** to scroll to **Smart call blk** and then press **MENU/SELECT**.
2. Press **▼ CID** or **▲** to select **Allow list** and then press **MENU/SELECT**.
3. Press **MENU/SELECT** to choose **Review**.
4. Press **▼ CID** or **▲** to browse through the allow list.



Save a caller ID log entry to allow list

1. Search for the desired caller ID log entry (see **Review the caller ID log**).
2. When the desired entry displays, press **MENU/SELECT**.
3. Press **▼ CID** or **▲** to scroll to **To Allow list**, then press **MENU/SELECT**.
4. The screen displays **Enter number**. Use the dialing keys to edit the number, when necessary.
 - Press **▼ CID** or **▲** to move the cursor to the left or right.
 - Press **MUTE/DELETE** to backspace and erase a digit.
 - Press and hold **MUTE/DELETE** to erase the entire entry.
 - Press and hold **REDIAL/PAUSE** to enter a 3-second dialing pause (a **P** appears).
5. Press **MENU/SELECT** to move to the name.
 - The screen shows **Enter name**.
6. Use the dialing keys to add or edit the name.
 - Press **▼ CID** or **▲** to move the cursor to the left or right.
 - Press **0** to add a space.
 - Press **MUTE/DELETE** to erase a character.
 - Press and hold **MUTE/DELETE** to erase all characters.
 - Press **TONE ✕** to change the next letter to upper or lower case.
7. Press **MENU/SELECT** to save.



Edit a allow list entry

1. Search for the desired entry in the call block list (see **Review allow list entries**).
2. When the desired entry appears, press **MENU/SELECT**. The handset displays **Enter number** and the stored number.
3. Use the dialing keys to edit the number, then press **MENU/SELECT**. The handset displays **Enter name** and then the stored name.
4. Use the dialing keys to edit the name. Additional key presses show other characters of that particular key. The first character of every word is capitalized.
5. Press **MENU/SELECT** to save. You hear a confirmation tone.

Delete an allow list entry

1. Search for the desired entry in the call block list (see **Review allow list entries**).
 2. When the desired entry displays, press **MUTE/DELETE**. The screen shows **Delete entry?**.
 3. Press **MENU/SELECT** to confirm. The screen show **Deleting...**. You hear a confirmation tone. You cannot retrieve a deleted entry.
- OR -**
1. Press **CALL BLOCK** when the handset is not in use.
- OR-**
- Press **MENU/SELECT** when the handset is not in use to enter the main menu. Then, press **▼ CID** or **▲**  to scroll to **Smart call blk** and then press **MENU/SELECT**.
2. Press **▼ CID** or **▲**  to select **Allow list** and then press **MENU/SELECT**.
 3. Press **MENU/SELECT** to choose **Review**.
 4. Press **▼ CID** or **▲**  to browse through the allow list.
 5. When the desired entry displays, press **MUTE/DELETE**. The screen shows **Delete entry?**.
 6. Press **MENU/SELECT** to confirm. The screen show **Deleting...**. You hear a confirmation tone. You cannot retrieve a deleted entry.

Delete all allow list entries



1. Press **CALL BLOCK** when the handset is not in use.
- OR-**
- Press **MENU/SELECT** when the handset is not in use to enter the main menu. Then, press **▼ CID** or **▲**  to scroll to **Smart call blk** and then press **MENU/SELECT**.
2. Press **▼ CID** or **▲**  to select **Allow list** and then press **MENU/SELECT**.
 3. Press **▼ CID** or **▲**  to select **Delete all**, and then press **MENU/SELECT**. The screen shows **Delete all?**.
 4. Press **MENU/SELECT** again to confirm. The screen displays **Deleting...**. There is a confirmation tone.

Star name list

There are many organizations like schools, medical offices, and pharmacies that use robocalls to communicate important information to you. Robocall uses an autodialer to deliver pre-recorded messages. By entering the **EXACT** Caller ID (CID)'s name of the organizations into the star name list, it ensures these calls will ring through when you only know the caller names but not their numbers.

If the first 15 characters of the incoming caller ID's name match a name saved in your star name list, the call will get through and ring. The star name list stores up to 10 names.

Add a star name entry

1. Press **CALL BLOCK** when the handset is not in use.
- OR-**
- Press **MENU/SELECT** when the handset is not in use to enter the main menu. Then, press **▼ CID** or **▲**  to scroll to **Smart call blk** and then press **MENU/SELECT**.
2. Press **▼ CID** or **▲**  to select **Starname list** and then press **MENU/SELECT**.
 3. Press **▼ CID** or **▲**  to select **Add new entry**, then press **MENU/SELECT**.
 4. When **Enter number** displays, use the dialing keys to enter the number.

-OR-

Copy a number from the redial list by pressing **REDIAL/PAUSE** and then press ▲ , ▼ **CID** or **REDIAL/PAUSE** repeatedly to select a number. Press **MENU/SELECT** to copy the number.

5. Press **MENU/SELECT** to move on to enter the name. The handset displays **Enter name**.
6. Use the dialing keys to enter the name. Additional key presses show other characters of that particular key. The first character of every word is capitalized.
7. Press **MENU/SELECT** to save. You hear a confirmation tone.

While entering names and numbers, you can:



- Press **MUTE/DELETE** to backspace and erase a digit or character.
- Press and hold **MUTE/DELETE** to erase the entire entry.
- Press ▼ **CID** or ▲  to move the cursor to the left or right.
- Press and hold **REDIAL/PAUSE** to insert a dialing pause (for entering numbers only).
- Press **0** to add a space (for entering names only).
- Press **TONE X** to change the next letter to upper or lower case.

Review star name list entries

1. Press **CALL BLOCK** when the handset is not in use.

-OR-

Press **MENU/SELECT** when the handset is not in use to enter the main menu. Then, press ▼ **CID** or ▲  to scroll to **Smart call blk** and then press **MENU/SELECT**.

2. Press ▼ **CID** or ▲  to select **Star name list** and then press **MENU/SELECT**.
3. Press **MENU/SELECT** to choose **Review**.
4. Press ▼ **CID** or ▲  to browse through the allow list.

Save a caller ID log entry to star name list

1. Search for the desired caller ID log entry (see **Review the caller ID log**).
2. When the desired entry displays, press **MENU/SELECT**.
3. Press ▼ **CID** or ▲  to scroll to **To Star name**, then press **MENU/SELECT**.
4. The screen shows **Star this name?**. Press **MENU/SELECT** to save.

Edit a star name list entry

1. Search for the desired entry in the call block list (see **Review star name list entries**).
2. When the desired entry appears, press **MENU/SELECT**. The handset displays **Enter name** along with the name to be edited.
3. Use the dialing keys to edit the name. Additional key presses show other characters of that particular key. The first character of every word is capitalized.
4. Press **MENU/SELECT** to save. You hear a confirmation tone.

Delete a star name list entry



1. Search for the desired entry in the call block list (see **Review star name list entries**).
2. When the desired entry displays, press **MUTE/DELETE**. The screen shows **Delete entry?**.
3. Press **MENU/SELECT** to confirm. The screen show **Deleting....**. You hear a confirmation tone. You cannot retrieve a deleted entry.

- OR -



1. Press **CALL BLOCK** when the handset is not in use.

-OR-

Press **MENU/SELECT** when the handset is not in use to enter the main menu. Then, press ▼ **CID** or ▲  to scroll to **Smart call blk** and then press **MENU/SELECT**.



2. Press ▼ **CID** or ▲  to select **Star name list** and then press **MENU/SELECT**.
3. Press **MENU/SELECT** to choose **Review**.
4. Press ▼ **CID** or ▲  to browse through the star name list.
5. When the desired entry displays, press **MUTE/DELETE**. The screen shows **Delete entry?**.
6. Press **MENU/SELECT** to confirm. The screen show **Deleting....**. You hear a confirmation tone. You cannot retrieve a deleted entry.

Delete all star name list entries

1. Press **CALL BLOCK** when the handset is not in use.
-OR-
Press **MENU/SELECT** when the handset is not in use to enter the main menu. Then, press ▼ **CID** or ▲  to scroll to **Smart call blk** and then press **MENU/SELECT**.
2. Press ▼ **CID** or ▲  to select **Star name list** and then press **MENU/SELECT**.
3. Press ▼ **CID** or ▲  to select **Delete all**, and then press **MENU/SELECT**. The screen shows **Delete all?**
4. Press **MENU/SELECT** again to confirm. The screen displays **Deleting...**. There is a confirmation tone.

Voice guide to set Smart call blocker

This feature is an easy and alternative way for you to do the basic setup of Smart call blocker. You can follow the voice guide to set your telephone system to allow or to screen all incoming home calls, or to screen home calls that do not display a phone number.

1. Press **CALL BLOCK** when the handset is not in use.
-OR-
Press **MENU/SELECT** when the handset is not in use to enter the main menu. Then, press ▼ **CID** or ▲  to scroll to **Smart call blk** and then press **MENU/SELECT**.
2. Press ▼ **CID** or ▲  to select **Voice guide** and then press **MENU/SELECT**.
3. You hear a voice prompt *"Hello! This voice guide will assist you with the basic setup of Smart call blocker..."*
4. Set up your Smart call blocker feature by inputting the designated numbers, as instructed in the voice guide.
 - Press **1** if you want to screen home calls with telephone numbers that are not saved in your phonebook, allow list or star name list; or
 - Press **2** if you do not want to screen calls, and want to allow all incoming calls to get through.

NOTES

- The screening feature of Smart call blocker is applicable to home calls only. All incoming cell calls will get through and ring. If you want to block a cell call, add the number to the block list. See **Block list**.
- You can press **OFF/CANCEL** to quit the voice guide at any time.
- After a power outage, the handset prompts you to set the date and time. After the date and time setting is done or skipped, the handset will prompt if you want to set up Smart call blocker via voice guide. Press **MENU/SELECT** to start the setup.

Screening announcements

If you have set profile to screen all unknown home calls (**Screen unknown**) or screen robocalls (**Screen robot**), the callers of the following incoming call categories will hear a screening announcement.

- Home calls that are "out of area" or with numbers set to "Private".
- Home calls with numbers that are not on your phonebook, allow list, or block list, or with absent caller ID number.
- Home calls with caller ID names that are not on your star name list.

There are two default screening announcements for screening unknown calls and screening robocalls on home line.

Screening with caller name - *"Hello. Calls to this number are being screened by Smart call blocker. Please say your name after the tone, then press pound."*

- This default announcement is played if you have set profile to screen all unknown home calls.

-OR-

Screening without caller name - *"Hello. Calls to this number are being screened by Smart call blocker. If you're a family member, friend or invited caller, please press pound to be connected. If you're a solicitor, please hang up now."*



- This default announcement is played if you have set profile to screen robocalls on home line.

You can use these announcements, or record your own name to replace “this number” in the announcements. Please refer to **Record your name for all screening announcements**.



NOTE

- For details of Smart call blocker's profile setting, see **Set profile**.



Play your current announcement of screening with caller name

1. Press **CALL BLOCK** when the handset is not in use.
-OR-
Press **MENU/SELECT** when the handset is not in use to enter the main menu. Then, press **▼ CID** or **▲**  to scroll to **Smart call blk** and then press **MENU/SELECT**.
2. Press **▼ CID** or **▲**  to select **Screening annnc** and then press **MENU/SELECT**.
3. Press **▼ CID** or **▲**  to select **Play annnc**, and then press **MENU/SELECT**.
4. Press **MENU/SELECT** again to select **w/ Caller name**.

Play your current announcement of screening without caller name



1. Press **CALL BLOCK** when the handset is not in use.
-OR-
Press **MENU/SELECT** when the handset is not in use to enter the main menu. Then, press **▼ CID** or **▲**  to scroll to **Smart call blk** and then press **MENU/SELECT**.
2. Press **▼ CID** or **▲**  to select **Screening annnc** and then press **MENU/SELECT**.
3. Press **▼ CID** or **▲**  to select **Play annnc**, and then press **MENU/SELECT**.
4. Press **MENU/SELECT** again to select **w/o Caller name**.

Record your name for all screening announcements

1. Press **CALL BLOCK** when the handset is not in use.
-OR-
Press **MENU/SELECT** when the handset is not in use to enter the main menu. Then, press **▼ CID** or **▲**  to scroll to **Smart call blk** and then press **MENU/SELECT**.
2. Press **▼ CID** or **▲**  to select **Screening annnc** and then press **MENU/SELECT**.
3. Press **MENU/SELECT** to select **Rec your name**. The system announces, *“Record after the tone. Press 5 when you are done.”*
4. Speak towards the handset to record your name. Press **5** to end recording.

To listen to the announcement with your recorded name again, scroll to **Play annnc** and press **MENU/SELECT**.

Reset all your screening announcements

1. Press **CALL BLOCK** when the handset is not in use.
-OR-
Press **MENU/SELECT** when the handset is not in use to enter the main menu. Then, press **▼ CID** or **▲**  to scroll to **Smart call blk** and then press **MENU/SELECT**.
2. Press **▼ CID** or **▲**  to select **Screening annnc** and then press **MENU/SELECT**.
3. Press **▼ CID** or **▲**  to select **Reset annnc** and then press **MENU/SELECT**. The screen shows **Reset annnc?**. Press **MENU/SELECT** again to confirm. The screen shows **Annnc reset.** before returning to the previous menu.

Your name will be deleted from all the screening announcements, and the telephone will use the default screening announcements. See **Screening announcements**.

Allowed calls

If Smart call blocker is on, the following types of incoming calls can get through to you and ring on your telephone system:

- Home calls with numbers saved in your allow list.
- Home calls with numbers saved in your phonebook, but not on your block list.
- Home calls with caller ID names saved in your star name list.
- Cell calls with numbers not saved in your block list.

NOTES

- When Smart call blocker is off, all incoming home and cell calls will ring on your telephone system, including calls with numbers saved in the block list.
- **Allow unknown** is the default profile setting. If you have not selected another profile, all unknown home calls will ring. However, the caller's numbers, if available, will not be saved to the allow list. If you want to save the caller's number to your allow list or block list, you can retrieve the number from caller ID log and save it to the allow list or block list. See [Save a caller ID log entry to the block list](#) and [Save a caller ID log entry to the allow list](#). If you want to retrieve the name from caller ID log and save it to the star name list. See [Save a caller ID log entry to the star name list](#).

Blocked calls

If Smart call blocker is on, incoming home or cell calls with numbers saved in your block list will not ring. The telephone plays the block announcement *"Calls to this number are being screened by Smart call blocker. The number you are calling is not accepting your call. Please hang up."* to the caller, and the call will be terminated.

NOTES

- When Smart call blocker is off, all incoming home and cell calls will ring on your telephone system, including calls with numbers saved in the block list.
- If you have set profile to **Block unknown**, all unknown home calls will be rejected. However, the caller's numbers, if available, will not be saved to the block list. If you want to save the caller's number to the block list, you can retrieve the number from caller ID log and save it to the block list. See [Save a caller ID log entry to the block list](#). You can also retrieve the number and save it to your allow list. See [Save a caller ID log entry to the allow list](#). If you want to retrieve the name from caller ID log and save it to the star name list. See [Save a caller ID log entry to the star name list](#).

Screen unknown home calls

If Smart call blocker is on, and you have set profile to screen unknown home calls, the telephone plays a screening announcement to the caller when receiving the following incoming home calls. It asks the caller to respond before putting the call through to you.



- Incoming home calls with numbers that are "out of area" or with numbers set to "Private";
- Incoming home calls with absent caller ID numbers;
- Incoming home calls with numbers that are not in your phonebook, allow list, nor block list; or
- Incoming home calls with names that are not in your star name list.

Screen calls and ask for caller names

When screening a home call, the telephone announces to the caller, *"Hello. Calls to this number are being screened by Smart call blocker. Please say your name after the tone, then press pound."* After the caller completes the request, the telephone announces to the caller *"Please wait a moment while your call is connected."* The telephone starts ringing and the handset screen displays **Screened call**. After you pick up the call, the telephone announces the caller's name, and then asks whether

you want to answer or reject the call, or to forward the call to the answering system.

NOTES

- You can set Smart call blocker to screen and filter all unknown home calls. You can easily add incoming phone numbers to your allow list and block list. This allows you to build up your lists of allowed and blocked numbers, and Smart call blocker will know how to deal with these calls when they come in again.
- The telephone announces to the caller with *"Hello. Calls to this number are being screened by Smart call blocker..."* If you have recorded your name in the screening announcements, your recorded name will replace *"this number"* in the announcements. See [Screening announcement](#).
- The screening feature of Smart call blocker is applicable to home calls only.
- If the caller hangs up before the home call is screened, or without leaving his/her name while the call is being screened, the call will be logged as missed call in the caller ID log.
- While a home call is being screened, you can press  **HOME/FLASH** or  to stop screening and answer the call.

- After the telephone screened a home call, and is ringing and announcing the caller's name, you can press **OFF/CANCEL** to mute the ringer, or press **CALL BLOCK** to reject the call directly.
- After you picked up a screened home call and the telephone is announcing the screening options, you can press **OFF/CANCEL** to hang up the call.
- If Smart call blocker is on and you receive a call waiting home call:
 - Smart call blocker will not screen a call waiting home call without number while on a call. You can press **HOME/FLASH** or **📞** to take the new call.
 - After you have picked up a screened home call, the telephone checks whether the call waiting number is in the phonebook, block list or allow list. It also checks whether the caller name is in the star name list. After that, The telephone then displays the caller ID information or "Blocked call" accordingly. You can press **HOME/FLASH** or **📞** to take the new call, or press **CALL BLOCK** on the handset to block it.
 - While the telephone is screening a home call, the new call will be ignored and logged as missed call in the caller ID log.
- Robocalls are unable to respond to the screening announcement, and therefore, will not get through

and ring. If you want to allow some robocalls to get through, save their names in the star name list. See **Star name list**.

Screened call options

After the telephone screen a home call and starts ringing, the handset screen displays **Screened call**. Press **HOME/FLASH** or **📞** to pick up the call.

After you picked up the call, the telephone announces *"Call from..."* and the caller's name, and then announces, *"To answer the call, press 1. To answer and always allow this number, press 2. To block this number, press 3. To send this call to the answering system, press 4. To repeat these options, press *"*.

Allow this call once:

- Press **1** to answer the call. The telephone number will not be added to your allow list.

Always allow this call:

- Press **2** to answer the call. The telephone number will be added to your allow list.

Block this call:

- Press **3** or **CALL BLOCK** to block the call. The telephone plays the block announcement *"The number you are calling is not accepting your call. Please hang up."* to the caller. The telephone number will be added to your block list.

Send this call to the answering system:

- Press **4** to forward the call to the answering system.

End this call:

- If you do not want to take the call, press **OFF/CANCEL** to end the call.

NOTES

- For home calls that are "out of area", "Private", or without caller ID, only options **1** and **4** will be available. The telephone announces *"To answer the call, press 1. To send this call to the answering system, press 4. To repeat these options, press *"*.
- If you select option **4** to send the call to the answering system, the caller can leave a message even if the answering system is off.
- When the telephone is ringing, you can press **MUTE/DELETE** to mute the ringer temporarily.

Screen robocalls

If Smart call blocker is on, and you have set profile to screen robocalls, the telephone plays a screening announcement to the caller when receiving the following incoming home calls. It asks the caller to press the pound key (#) before putting the call through to you.





- Incoming home calls with numbers that are "out of area" or with numbers set to "Private";
- Incoming home calls with absent caller ID numbers;
- Incoming home calls with numbers that are not in your phonebook, allow list, nor block list; or
- Incoming home calls with names that are not in your star name list.



Screen calls without asking for caller names

When screening a home call, the telephone announces to the caller, *"Hello. Calls to this number are being screened by Smart call blocker. If you're a family member, friend or invited caller, please press pound to be connected. If you're a solicitor, please hang up now."* After the caller presses the pound key (#), the telephone announces to the caller *"Please wait a moment while your call is connected."* The telephone starts ringing, and you can answer the call.

This option is suitable for you to filter calls that uses autodialers to deliver prerecorded messages, for example, robocalls and telemarketing calls.

NOTES

- The telephone announces to the caller with *"Hello. Calls to this number are being screened by Smart call blocker..."* If you have recorded your name in the screening announcements, your recorded name will replace *"this number"* in the announcements. See **Screening announcement**.
- The screening feature of Smart call blocker is applicable to home calls only.
- While a home call is being screened, you can press  **HOME/FLASH** or  to stop screening and answer the call.
- If Smart call blocker is on and you receive a call waiting home call:
 - Smart call blocker will not screen a call waiting home call without number while on a call. You can press  **HOME/FLASH** or  to take the new call.
 - After you have picked up a screened home call, the telephone checks whether the call waiting number is in the phonebook, block list or allow list. It also checks whether the caller name is in the star name list. After that, The telephone then displays the caller ID information or "Blocked call" accordingly. You

can press  **HOME/FLASH** or  to take the new call, or press **CALL BLOCK** on the handset to block it.

- While the telephone is screening a home call, the new call will be ignored and logged as missed call in the caller ID log.
- Robocalls are unable to respond to the screening announcement, and therefore, will not get through and ring. If you want to allow some robocalls to get through, save their names in the star name list. See **Star name list**.

Option while on a call

When you are on a home or cell call and speaking to the caller, and you do not want to receive calls from this caller again, you can press **CALL BLOCK** to end the call. The telephone plays the block announcement *"The number you are calling is not accepting your call. Please hang up."* to the caller, and the call will be terminated. The caller's number, if available, will be added to your block list.

- Press **CALL BLOCK** on the handset. The screen displays **Block and end?** and the caller's number, if available. Press **MENU/SELECT** to end the call.

NOTE

- You can press **CALL BLOCK** on the handset to end the call even if Smart call blocker is turned off.

Voicemail (via Telephone service provider)

When you received a voicemail, the handset displays  and **New voicemail**.

To retrieve, you typically dial an access number provided by your telephone service provider, followed by a security code or PIN.

Some service providers bundle or combine multiple services like voicemail and call waiting, so you may not be aware that you have voicemail. To check what services you have and how to access them, contact your telephone service provider.



NOTE

- After you have listened to all new voicemail messages, the indicators on the screen turn off automatically.

Clear the new voicemail indicators

If you have retrieved your voicemail while away from home, and the handset still displays the new voicemail indicators, use this feature to turn off the indicators.

This feature only turns off the displayed **New voicemail** and the ; it does not delete your voicemail messages. As long as you have new voicemail messages, your telephone service provider continues to send the signal to turn on the indicator.

1. Press **MENU/SELECT** in idle mode.
2. Press **▼ CID** or **▲**  to highlight **Settings**, then press **MENU/SELECT**.
3. Press **▼ CID** or **▲**  to highlight **Clr voicemail**, then press **MENU/SELECT** to turn the voicemail indicator off.

NOTES

- Your telephone service provider voicemail might alert you to new messages with a stutter (broken) dial tone. Contact your telephone service provider for more details.
- For information about using your voicemail service, contact your telephone service provider.

Configure | Settings

Dial modes

Temporary tone dialing

If you have pulse (rotary) service only, you can switch from pulse to touch-tone dialing temporarily during a call. This is useful if you need to send touch-tone signals to access your telephone banking or long distance services.



During a call

1. Press **-tone X** on the handset.
2. Use the dialing keys to enter the relevant number. The telephone sends touch-tone signals.
3. The telephone automatically returns to pulse dialing after you end the call.

Set dial mode

The dial mode is preset to tone dialing. If you have pulse (rotary) service, you must change the dial mode to pulse dialing before using the telephone.

To set the dial mode

1. Press **MENU/SELECT** in idle mode.
2. Press **▼ CID** or **▲**  to highlight **Settings**, then press **MENU/SELECT**.
3. Press **▼ CID** or **▲**  to highlight **Dial mode**, then press **MENU/SELECT**.
4. Press **▼ CID** or **▲**  to choose **Touch-tone** or **Pulse**, then press **MENU/SELECT**.

NOTE



- If you have dial pulse (rotary) dialing service only, refer to **Temporary tone dialing** to temporarily switch from pulse to touch-tone dialing during a call.

Ringer



Set ringer tone

You can select the ringer tones for incoming home and cell calls.

To set the ringer tone on home line:

1. Press **MENU/SELECT** in idle mode.
2. Press **▼ CID** or **▲**  to highlight **Ringers**, then press **MENU/SELECT**.
3. Press **▼ CID** or **▲**  to select **Home ringtone**, then press **MENU/SELECT**.
4. Press **▼ CID** or **▲**  to sample each ringer tone for home line.
5. Press **MENU/SELECT** to save. You hear a confirmation tone.

To set the ringer tone on cell lines:

1. Press **MENU/SELECT** in idle mode.
2. Press **▼ CID** or **▲**  to highlight **Ringers**, then press **MENU/SELECT**.
3. Press **▼ CID** or **▲**  to select **Cell ringtone**, then press **MENU/SELECT**.
4. Press **▼ CID** or **▲**  to sample each ringer tone for cell lines.

5. Press **MENU/SELECT** to save. You hear a confirmation tone.

NOTE



- If you turn off the ringer volume, you will not hear ringer tone samples.

Set ringer volume



Handset ringer volume

You can adjust the handset ringer volume level, or turn the ringer off.

To set the ringer volume on home line:

1. Press **MENU/SELECT** in idle mode.
2. Press **▼ CID** or **▲**  to highlight **Ringers**, then press **MENU/SELECT** twice.
3. Press **MENU/SELECT** to select **Home volume**.
4. Press **▼ CID** or **▲**  to sample each ringer volume level for home line.
5. Press **MENU/SELECT** to save.

To set the ringer volume on cell lines:

1. Press **MENU/SELECT** in idle mode.
2. Press **▼ CID** or **▲**  to highlight **Ringers**, then press **MENU/SELECT** twice.
3. Press **▼ CID** or **▲**  to highlight **Cell volume**, then press **MENU/SELECT** twice.
4. Press **▼ CID** or **▲**  to sample each ringer volume level for cell lines.
5. Press **MENU/SELECT** to save.

NOTES



- If the ringer volume is set to **Off**, the idle screen displays .
- When the ringer volume is set to **Off**, the handset still rings when you press **FIND HS** at the telephone base.

Set date and time

The answering system announces the day and time of each message prior to playing it. Before using the answering system, set the date and time as follows. If you subscribe to caller ID service, the day, month and time are set automatically with each incoming call. However, the year must be correct so that the day of the week can be calculated from the caller ID information.

After handset registration or a power failure, the handset will prompt you to set the date and time.

To set the date and time manually



1. Press **MENU/SELECT** in idle mode.
2. Press **▼ CID** or **▲**  to highlight **Set date/time**, then press **MENU/SELECT**.
3. Use the dialing keys (**0-9**) to enter the month (**MM**), date (**DD**) and year (**YY**). Then press **MENU/SELECT**.
4. Use the dialing keys (**0-9**) to enter the hour (**HH**) and minute (**MM**). Then press **▼ CID** or **▲**  to choose **AM** or **PM**.
5. Press **MENU/SELECT** to save your setting. You hear a confirmation tone.

Set languages

Set LCD language

You can select English, French, or Spanish to be used for all screen displays.

To select the LCD language

1. Press **MENU/SELECT** in idle mode.
2. Press **▼ CID** or **▲**  to highlight **Settings**, and then press **MENU/SELECT**.
3. Press **MENU/SELECT** to select **LCD language**.
4. Press **▼ CID** or **▲**  to highlight **English, Français** or **Español**, and then press **MENU/SELECT** to confirm.

NOTE



- If you accidentally change the LCD language to French or Spanish, you can reset it back to English without going through the French or Spanish menus. Press **MENU/SELECT** in idle mode, then enter ***364#**. There is a confirmation tone.

Set Smart call blocker language

NOTE

- This feature is exclusive for Canada version.

You can set the Smart call blocker voice language to English or French:

1. Press  **HOME/FLASH** or  when the handset is not in use.
2. Enter ***364#** to set the voice language to English; or enter ***373#** to set it to French.
 - When the voice language is successfully set, the handset prompts "*Voice language is set to English.*" or "*Le langage vocal est réglé sur le français.*"
3. The handset will then return to idle.













Sound settings

Set number of rings

You can set the answering system to answer an incoming call after two, three, four, five or six rings; or toll saver.

If you choose toll saver, the answering system answers a call after two rings when you have new messages, or after four rings when you have no new messages. This enables you to check for new messages and avoid paying unnecessary long distance charges if you are calling from outside your local area.

To set the number of rings

1. Press **MENU/SELECT** in idle mode.
2. Press  **CID** or   to highlight **Answering sys**, then press **MENU/SELECT**.
3. Press  **CID** or   to highlight **Ans sys setup**, then press **MENU/SELECT**.
4. Press  **CID** or   to highlight **# of rings**, then press **MENU/SELECT**.
5. Press  **CID** or   to choose from **6**, **5**, **4**, **3**, **2** or **Toll saver**.
6. Press **MENU/SELECT** to save.

NOTE

- If Smart call blocker is on, the first ring of all calls will be muted.

Set QUIET mode

When **QUIET** mode is turned on, the telephone silences all sounds during the set period of time (1-12 hours). However, the handset locator paging tone and any sound-generating operations initiated by users, such as making calls using the speakerphone or setting ringer volume, will sound as normal. After you turn on **QUIET** mode, this feature activates immediately.

To turn QUIET mode on

1. Press and hold **QUIET #** when the telephone is not in use.
2. The screen displays **Quiet: _ _ hours**. Use the dialing keys (**0-9**) to enter the desired duration (1-12).
3. Press **MENU/SELECT** to save. You hear a confirmation tone.

The screen displays **Quiet mode on** and .

NOTE

- When you change the settings of the ringer tone or ringer volume, you can still hear the samples even if the quiet mode is on.

To turn QUIET mode off

Press and hold **QUIET #** when the telephone is not in use. The screen displays **Quiet mode off** briefly and then returns to idle.

Set listening volume

While on a call, you can adjust the listening volume on the handset.









- Press  **/VOLUME/**  on the handset while on a call.

Set key tone

The handset is set to beep with each key press. You can adjust the key tone volume or turn it off.

If you turn off the key tone, there are no beeps when you press keys.

To set the key tone



1. Press **MENU/SELECT** in idle mode.
2. Press  **CID** or   to highlight **Settings**, then press **MENU/SELECT**.
3. Press  **CID** or   to highlight **Key tone**, then press **MENU/SELECT**.
4. Press  **CID** or   to select **On** or **Off**.
5. Press **MENU/SELECT** to confirm.

Voicemail settings

Set speed dial voicemail number

This feature lets you save your voicemail number for quick access when you press and hold the  **1** key.

To set your voicemail number

1. Press **MENU/SELECT** in idle mode.
2. Press **▼ CID** or **▲**  to highlight **Settings**, then press **MENU/SELECT**.
3. Press **▼ CID** or **▲**  to highlight **Voicemail #**, then press **MENU/SELECT**.
4. Use the dialing keys to enter the voicemail access number (up to 30 digits) provided by your telephone service provider.
5. Press **MENU/SELECT** to confirm.

Add and register handset

You can add new **LS6300** handsets (purchased separately) to your **LS6331/LS6331-2/LS6331-3/LS6331-4/LS6331-5** telephone system. Your telephone system supports a maximum of 5 handsets.

Each handset must be registered with the telephone base before use. When first purchased, each expansion handset displays **To register HS...** and **... see manual** alternately.

NOTES

- Charge the new handset without interruption for at least 30 minutes before registering it to the telephone base.
- You cannot register a handset if any other system handset is in use.

To register a handset to your telephone base

1. Before you begin registration, make sure the handset is out of the charger and shows **To register HS...** and **...see manual**.
2. Press and hold **FIND HS** on the telephone base for about four seconds.
3. Press **QUIET #** on the handset and it shows **Registering...** The handset shows **Registered** and you hear a beep when the registration process completes. This process takes about 60 seconds.

If registration fails, **Failed** appears on the handset screen. The handset shows **To register HS...** and **... see manual** alternately. Start again from Step 1.

General product care

Taking care of your telephone

Your cordless telephone contains sophisticated electronic parts, so it must be treated with care.

Avoid rough treatment

Place the handset down gently. Save the original packing materials to protect your telephone if you ever need to ship it.

Avoid water

Your telephone can be damaged if it gets wet. Do not use the handset outdoors in the rain, or handle it with wet hands. Do not install the telephone base near a sink, bathtub or shower.

Electrical storms

Electrical storms can sometimes cause power surges harmful to electronic equipment. For your own safety, take caution when using electrical appliances during storms.

Cleaning your telephone

Your telephone has a durable plastic casing that should retain its luster for many years. Clean it only with a dry non-abrasive cloth. Do not use dampened cloth or cleaning solvents of any kind.

Technical specifications

Frequency control	<ul style="list-style-type: none"> Crystal controlled PLL synthesizer
Transmit frequency	<ul style="list-style-type: none"> Handset: 1921.536-1928.448 MHz Telephone base: 1921.536-1928.448 MHz
Channels	<ul style="list-style-type: none"> 5
Nominal effective range	<ul style="list-style-type: none"> Maximum power allowed by FCC and IC. Actual operating range may vary according to environmental conditions at the time of use.
Power requirement	<ul style="list-style-type: none"> Handset: 2.4V Ni-MH battery Telephone base: 6V DC @ 0.4A Charger: 6V DC @ 0.4A
Memory	<ul style="list-style-type: none"> Phonebook: 1000 memory locations; up to 30 digits and 15 characters Caller ID log: 50 memory locations; up to 24 digits and 15 characters Call block: 1000 entries

When it is fully charged, you can expect the following performance.

Operation	Operating time*
Talk time (cordless handset)	<ul style="list-style-type: none"> 10 hours
Standby	<ul style="list-style-type: none"> 5 days

* Operating times vary depending on your actual use and the age of the battery.

Disclaimer and Limitation of Liability

VTech Communications, Inc. and its suppliers assume no responsibility for any damage or loss resulting from the use of this user's manual. VTech Communications, Inc. and its suppliers assume no responsibility for any loss or claims by third parties that may arise through the use of this product.

Company: VTech Communications, Inc.

Address: 9020 SW Washington Square Road - Ste 555 Tigard, OR 97223, United States

Phone: 1 (800) 595-9511 in the U.S. or 1 (800) 267-7377 in Canada

DECT 6.0 digital technology

The VTech DECT 6.0 products offer unsurpassed range performance and sound clarity. This is achieved through a unique antenna design and advances in noise-filtering technology. An independent laboratory has confirmed that VTech DECT 6.0 products perform up to 45% better in range competitions against similarly equipped phones of the leading competition. Now, calls can be taken in the basement, backyard and garage with exceptional sound quality.

Telephone operating range

This cordless telephone operates within the maximum power allowed by the Federal Communications Commission (FCC). Even so, this handset and telephone base can communicate over a certain distance – which can vary with the locations of the telephone base and handset, the weather, and the construction of your home or office.

Redefining long range coverage and clarity

This telephone base comes with an antenna which gives much better clarity and covers a longer range than before.

Simulated full-duplex handset and base speakerphones

This simulated full-duplex speakerphone on your handset and telephone base allow both ends of a call to speak and be heard at the same time. Optimal performance is subject to external factors and individual usage.

Frequently asked questions

Below are the questions most frequently asked about the cordless telephone. If you cannot find the answer to your question, visit our U.S. website at

www.vtechphones.com or call

1 (800) 595-9511 for customer service. In Canada, go to phones.vtechcanada.com or call **1 (800) 267-7377**.

My telephone does not work at all.	Make sure the telephone base is installed properly, and battery is installed and charged correctly. For optimum daily performance, return the handset to the telephone base after use.	
The display shows No line . I cannot hear the dial tone.	Disconnect the telephone line cord from your telephone and connect it to another telephone. If there is no dial tone on that other telephone either, then the telephone line cord may be defective. Try installing a new telephone line cord. If changing the telephone line cord does not help, the wall jack (or the wiring to this wall jack) may be defective. Contact your telephone service provider.	
	You may be using a new cable or VoIP service, the existing telephone jacks in your home may no longer work. Contact your service provider for solutions.	
	The display shows To register HS... and ...see manual alternately. The handset does not work at all.	The handset is deregistered from the telephone base. Place the handset in the telephone base to register it back. The handset shows Registered and you hear a beep when the registration process completes. This process takes about 60 seconds to complete.
	The display shows Low battery .	Place the handset in the handset charger for charging.
	The battery does not charge in the handset or the handset battery does not accept charge.	Make sure the handset is placed in the handset charger correctly. If the battery is completely depleted, charge the battery for at least 30 minutes before use. You may need to purchase a new battery.
	The telephone does not ring when there is an incoming call.	Make sure the ringer volume is not set to off. The handset may be too far from the telephone base. Move it closer to the telephone base.
My handset beeps and is not performing normally.	Move the handset closer to the telephone base. It may be out of range.	
I hear noise on the cordless handset and the keys do not work.	Make sure the telephone line cord is plugged in securely.	

I hear other calls when using the telephone.	Disconnect the telephone base from the telephone wall jack. Plug in a different telephone. If you still hear other calls, the problem is probably in the wiring or telephone service. Contact your telephone service provider.
There is interference during a telephone conversation. My calls fade out when I am using the cordless handset.	The handset may be out of range. Move it closer to the telephone base.
	If you subscribe to high-speed Internet service (DSL - digital subscriber line) through your telephone line, you must install a DSL filter between the telephone line cord and the telephone wall jack. The filter prevents noise and caller ID problems caused by DSL interference. Contact your DSL service provider for more information about DSL filters.
	Appliances or other cordless telephones plugged into the same circuit as the telephone base can cause interference. Try moving the appliance or telephone base to another outlet.
	The location of your telephone base can impact the performance of your cordless phone. For better reception, install the telephone base in a centralized location within your home or office, away from walls or other obstructions. In many environments, elevating the telephone base improves overall performance.

The telephone does not receive caller ID or the telephone does not show caller ID during call waiting.	Caller ID is a subscription service. You must subscribe to this service from your telephone service provider for this feature to work on your telephone.
	Both your and the caller's telephone service providers must use equipment compatible with the caller ID service.
	The caller may not be calling from an area which supports caller ID The caller ID information displays after the first or second ring.
The display shows Out of range or no pwr at base .	The handset may be out of range. Move it closer to the telephone base. Make sure the power cord is securely plugged into the telephone base. Use a working electrical outlet not controlled by a wall switch.
	I cannot hear any instruction from the handset when I try to record, play or delete my own announcement.
The outgoing announcement is not clear.	When recording the announcement, make sure you speak in a normal tone of voice towards the microphone of the handset. Make sure there is no background noise when recording.

The answering system does not record messages.	Make sure the answering system is on. When the answering system is on, ANS ON should display on the handset.
	When the answering machine memory is full, it does not record new messages until some old messages are deleted.
	If you subscribe to voicemail service, change the number of rings so that your answering system answers before your voicemail service answers. To determine how many rings activate your voicemail service, contact your telephone service provider.
The messages on the answering system are very difficult to hear.	Press ▲/VOLUME on the handset to increase the listening volume.
The answering system does not announce the correct day of the week for recorded messages time stamp.	Make sure you have set the date and time. See Set date and time section.
The messages on the answering system are incomplete.	The maximum length for a message is four minutes. If a caller leaves a very long message, i.e., more than four minutes, part of it may be lost when the answering system disconnects the call.
	If the memory on the answering system becomes full during a message, the answering system stops recording and disconnects the call.
	If the caller's voice is very soft, the answering system may stop recording and disconnect the call.

The answering system does not respond to remote commands.	Make sure you enter the correct remote access code.
	Make sure you are calling from a touch-tone telephone. When dialing a number, there should be tones. If there are clicks, then it is not a touch-tone telephone and cannot activate the answering system.
	The answering system may not detect the remote access code when your announcement is playing. Wait until the announcement is over before entering the code.
I subscribe to a nontraditional telephone service that uses my computer to establish connections, and my telephone doesn't work.	Make sure your computer is powered on, and your Internet is working properly.
	Make sure to plug your USB telephone adapter into a dedicated USB port on your computer. Do not plug into a multiple port USB hub (USB splitter) that is not powered.
	In a few rare instances, the USB port on your computer may not have enough power. In these instances, try using a USB hub with its own external power supply.
I accidentally set my LCD language to Spanish or French, and I don't know how to change it back to English.	If you are using a firewall, it may prevent access to your nontraditional telephone service. Contact your service provider for more information.
	While the handset is not in use, press MENU/SELECT and then enter *364# to change the handset LCD language back to English.

Limited Warranty

What does this limited warranty cover?

The manufacturer of this VTech Product warrants to the holder of a valid proof of purchase ("Consumer" or "you") that the Product and all accessories provided in the sales package ("Product") are free from defects in material and workmanship, pursuant to the following terms and conditions, when installed and used normally and in accordance with the Product operating instructions. This limited warranty extends only to the Consumer for Products purchased and used in the United States of America and Canada.

What will VTech do if the Product is not free from defects in materials and workmanship during the limited warranty period ("Materially Defective Product")?

During the limited warranty period, VTech's authorized service representative will replace at VTech's option, without charge, a Materially Defective Product. If we replace the Product, we may use new or refurbished replacement parts. If we choose to replace the Product, we may replace it with a new or refurbished Product of the same or similar design. We will retain defective parts, modules, or equipment. Replacement of the Product, at VTech's option, is your exclusive remedy. VTech will return the replacement Products to you in working condition. You should expect the replacement to take approximately 30 days.

How long is the limited warranty period?

The limited warranty period for the Product extends for ONE (1) YEAR from the date of purchase. If VTech replaces a Materially Defective Product under the terms of this limited warranty, this limited warranty also applies to the replacement Product for a period of either (a) 90 days from the date the replacement Product is shipped to you or (b) the time remaining on the original one-year warranty; whichever is longer.

What is not covered by this limited warranty?

This limited warranty does not cover:

1. Product that has been subjected to misuse, accident, shipping or other physical damage, improper installation, abnormal operation or

handling, neglect, inundation, fire, water or other liquid intrusion.

2. Product that has been subjected to contact with liquid, water, rain, extreme humidity or heavy perspiration, sand, dirt or the like; but then only to the extent the damage was not caused by incorrectly securing the waterproof handset's protective elements, for example, failing to properly close a seal), or such protective elements are damaged or missing (e.g. a cracked battery door), or subjecting a Product to conditions beyond its stated specifications or limits (e.g. 30 minutes in 1 meter of fresh water).
3. Product that has been damaged due to repair, alteration or modification by anyone other than an authorized service representative of VTech;
4. Product to the extent that the problem experienced is caused by signal conditions, network reliability, or cable or antenna systems;
5. Product to the extent that the problem is caused by use with non-VTech accessories;
6. Product whose warranty/quality stickers, product serial number plates or electronic serial numbers have been removed, altered or rendered illegible;
7. Product purchased, used, serviced, or shipped for repair from outside the United States of America or Canada, or used for commercial or institutional purposes (including but not limited to Products used for rental purposes);
8. Product returned without a valid proof of purchase (see item 2 below); or
9. Charges for installation or set up, adjustment of customer controls, and installation or repair of systems outside the unit.

How do you get warranty service?

To obtain warranty service in the USA, please visit our website at www.vtechphones.com or call

1 (800) 595-9511.

To obtain warranty service in Canada, go to phones.vtechcanada.com or dial 1 (800) 267-7377.

NOTE: Before calling for service, please review the user's manual - a check of the Product's controls and features may save you a service call.

Except as provided by applicable law, you assume the risk of loss or damage during transit and transportation and are responsible for delivery or handling charges incurred in the transport of the Product(s) to the service location. VTech will return replaced Product under this limited warranty. Transportation, delivery or handling charges are prepaid.

VTech assumes no risk for damage or loss of the Product in transit. If the Product failure is not covered by this limited warranty, or proof of purchase does not meet the terms of this limited warranty, VTech will notify you and will request that you authorize the cost of replacement prior to any further replacement activity. You must pay for the cost of replacement and return shipping costs for the replacement of Products that are not covered by this limited warranty.

What must you return with the Product to get warranty service?

1. Return the entire original package and contents including the Product to the VTech service location along with a description of the malfunction or difficulty; and
2. Include a "valid proof of purchase" (sales receipt) identifying the Product purchased (Product model) and the date of purchase or receipt; and
3. Provide your name, complete and correct mailing address, and telephone number.

Other limitations

This warranty is the complete and exclusive agreement between you and VTech. It supersedes all other written or oral communications related to this Product. VTech provides no other warranties for this Product. The warranty exclusively describes all of VTech's responsibilities regarding the Product. There are no other express warranties. No one is authorized to make modifications to this limited warranty and you should not rely on any such modification.

State/Provincial Law Rights: This warranty gives you specific legal rights, and you may also have other rights, which vary from state to state or province to province.

Limitations: Implied warranties, including those of fitness for a particular purpose and merchantability (an unwritten warranty that the Product is fit for ordinary use) are limited to one year from the date of purchase. Some states/provinces do not allow limitations on how long an implied warranty lasts, so the above limitation may not apply to you. In no event shall VTech be liable for any indirect, special, incidental, consequential, or similar damages (including, but not limited to lost profits or revenue, inability to use the Product or other associated equipment, the cost of substitute equipment, and claims by third parties) resulting from the use of this Product. Some states/provinces do not allow the exclusion or limitation of incidental or consequential damages, so the above limitation or exclusion may not apply to you.

Please retain your original sales receipt as proof of purchase

Disclaimer and Limitation of Liability

VTech Communications, Inc. and its suppliers assume no responsibility for any damage or loss resulting from the use of this user's manual. VTech Communications, Inc. and its suppliers assume no responsibility for any loss or claims by third parties that may arise through the use of this product.

Company: VTech Communications, Inc.

Address: 9020 SW Washington Square Road - Ste 555 Tigard, OR 97223, United States

Phone: 1 (800) 595-9511 in the U.S. or 1 (800) 267-7377 in Canada

Go to www.vtechphones.com (US) to register your product for enhanced warranty support and the latest VTech product news.

Go to phones.vtechcanada.com (Canada) for the latest VTech product news.



Recycle this product when you are done with it

Scan the QR code on the right or visit www.vtechphones.com/recycle.



(For the US only)



Specifications are subject to change without notice.

© 2024 VTech Communications, Inc. |

© 2024 VTech Technologies Canada Ltd.

All rights reserved. v1.0. 06/24.