



vtech

Quick start guide
(Canada version)

For more support information



Congratulations

on purchasing your new VTech product. Before using this HD video monitor, please read **Important safety instructions**. For support, shopping, and everything new at VTech, visit our website at www.vtechcanada.com.

What does HD Video Monitor do?

VTech 7-inch Smart Wi-Fi 1080p Video Monitor allows you to stay close to your baby when you are on the move or away. This monitor is Wi-Fi enabled, which uses your home wireless network to stream live video and audio through the HD baby unit and 7-inch color screen parent unit. It allows you to maintain a constant connection to your baby.

You can also monitor from your smartphone and mobile tablet. VTech 7-inch Smart Wi-Fi 1080p Video Monitor uses **MyVTech Baby Pro** app to let you instantly see and hear what's happening with your baby from anywhere in the world. The app can be downloaded from the App Store or the Google Play™ Store, directly from your smartphone or mobile tablet.

IMPORTANT SAFETY INSTRUCTIONS

- The applied nameplate is located at the bottom of the baby unit's base.
- When using your equipment, basic safety precautions should always be followed to reduce the risk of fire, electric shock and injury, including the following:
- Follow all warnings and instructions marked on the product.
 - Adult setup is required.
 - CAUTION:** Do not install the baby unit at a height above 2 meters.
 - This product is not a substitute for adult supervision of the infant. Supervising the infant is the parent's or caregiver's responsibility. This product could cease operating, and therefore you should not assume it will continue working properly for any given period of time. Further, this is not a medical device and should not be used as such. This product is intended to assist you in supervising your baby.
 - Do not use this product near water. For example, do not use it next to a bath tub, wash bowl, kitchen sink, laundry tub or swimming pool, or in a wet basement or shower.
 - CAUTION:** Use only the battery provided. There may be a risk of explosion if a wrong type of battery is used for the parent unit. The battery cannot be subjected to high or low extreme temperature and low air pressure at high altitude during use, storage or transportation. Disposal of battery into fire of a hot oven, or mechanically crushing or cutting of the battery can result in an explosion. Leaving the battery in an extremely high temperature surrounding environment can result in an explosion or the leakage of flammable liquid or gas. Battery subjected to extremely low air pressure may result in an explosion or the leakage of flammable liquid or gas. Dispose of used battery according to the information in **The NBC wall**.
 - Use only the adapters included with this product. Incorrect adapter polarity or voltage can seriously damage the product.
- Power adapter information:**
Parent unit and baby unit output: 5V DC 2A
VTech Telecommunications Ltd.
Model: VT07EUS05200
- Rechargeable battery information:**
3.8V 5000mAh Lithium-ion Polymer battery
Zhongshan Tianmao Battery Co., Ltd.
Model Number: BP1263
- The power adapters are intended to be correctly oriented in a vertical or floor mount position. The prongs are not designed to hold the plug in place if it is plugged into a ceiling, under-the-table or cabinet outlet.
 - For pluggable equipment, the socket-outlet shall be easily accessible.
 - Unplug this product from the wall outlet before cleaning. Do not use liquid or aerosol cleaners. Use a damp cloth for cleaning.
 - Do not cut off the power adapters to replace them with other plugs, as this causes a hazardous situation.
 - Do not allow anything to rest on the power cords. Do not install this product where the cords may be walked on or crimped.
 - This product should be operated only from the type of power source indicated on the marking label. If you are not sure of the type of power supply in your home, consult your dealer or local power company.
 - The equipment is to be supplied from an identified USB port complying with the requirements of Limited Power Source.
 - Do not overload wall outlets or use an extension cord.
 - Do not place this product on an unstable table, shelf, stand or other unstable surface.
 - This product should not be placed in any area where proper ventilation is not provided. Slots and openings in the back or bottom of this product are provided for ventilation. To protect them from overheating, these openings must not be blocked by placing the product on a soft surface such as a bed, sofa or rug. This product should never be placed near or over a radiator or heat register.
 - Never push objects of any kind into this product through the slots because they may touch dangerous voltage points or create a short circuit. Never spill liquid of any kind on the product.
 - To reduce the risk of electric shock, do not disassemble this product, but take it to an authorized service facility. Opening or removing parts of the product other than specified access doors may expose you to dangerous voltages or other risks. Incorrect reassembly can cause electric shock when the product is subsequently used.
 - You should test the sound reception every time you turn on the units or move one of the components.
 - Periodically examine all components for damage.
 - There is a very low risk of privacy loss when using certain electronic devices, such as baby monitors, cordless telephones, etc. To protect your privacy, make sure the product has never been used before purchase, reset the baby monitor periodically by powering off and then powering on the units, and power off the baby monitor if you will not use it for some time.
 - Children should be supervised to ensure that they do not play with the product.
 - The product is not intended for use by persons (including children) with reduced physical, sensory or mental capabilities, or lack of experience and knowledge, unless they have been given supervision or instruction concerning use of the appliance by a person responsible for their safety.
- SAVE THESE INSTRUCTIONS**
- Cautions**
- Use and store the product at a temperature between 0°C and 40°C.
 - Do not expose the product to extreme cold, heat or direct sunlight. Do not put the product close to a heating source.
 - Batteries should not be exposed to excessive heat such as bright sunshine or fire.
- Warning—Strangulation Hazard—**
Children have STRANGLED in cords. Keep this cord out of the reach of children (more than 0.9m away. Do not remove this tag).
- Never place the baby unit(s) inside the baby's crib or playpen. Never cover the baby unit(s) or parent unit with anything such as a towel or a blanket.
 - Other electronic products may cause interference with your baby monitor. Try installing your baby monitor as far away from these electronic devices as possible: wireless routers, radios, cellular telephones, intercoms, room monitors, televisions, personal computers, kitchen appliances and cordless telephones.
- Precautions for users of implanted cardiac pacemakers**
Cardiac pacemakers (applies only to digital cordless devices):
Wireless Technology Research, LLC (WTR), an independent research entity, led a multidisciplinary evaluation of the interference between portable wireless devices and implanted cardiac pacemakers. Supported by the U.S. Food and Drug Administration, WTR recommends to physicians that:
- Pacemaker patients**
- Should keep wireless devices at least six inches from the pacemaker.
 - Should NOT place wireless devices directly over the pacemaker, such as in a breast pocket, when it is turned ON. WTR's evaluation did not identify any risk to bystanders with pacemakers from other persons using wireless devices.
- Electromagnetic fields (EMF)**
This VTech product complies with all standards regarding electromagnetic fields (EMF), if handled properly and according to the instructions in this user's manual, the product is safe to be used based on scientific evidence available today.

WHAT'S IN THE BOX

Your HD video monitor package contains the following items. Save your sales receipt and original packaging in the event warranty service is necessary.

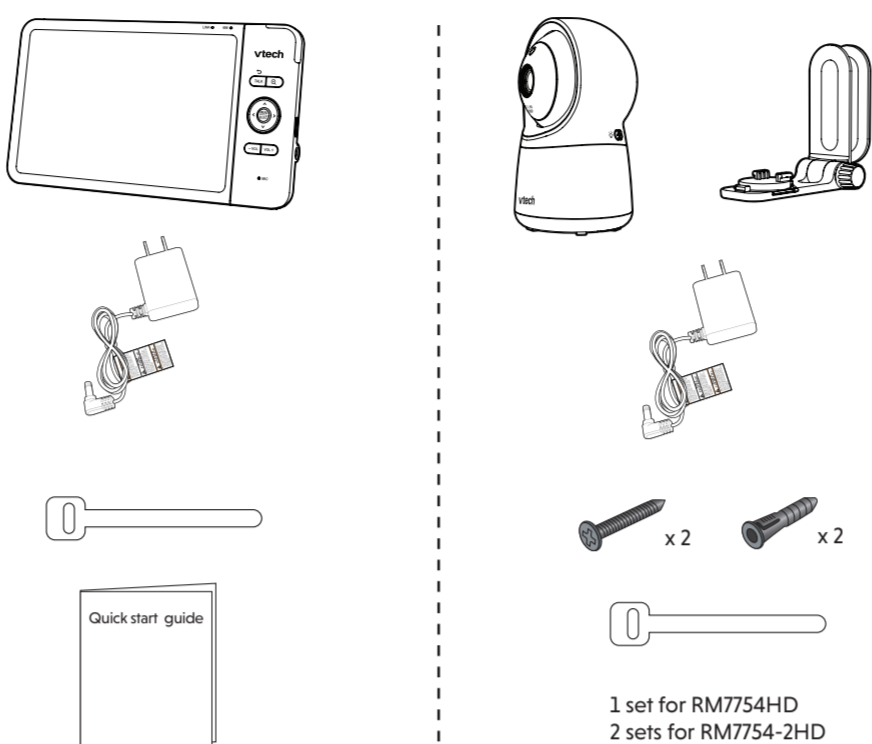

Requirements

For mobile access:

MyVTech Baby 1080p mobile app	
Network	Wi-Fi
Wi-Fi router	2.4GHz 802.11 b/g/n
Internet connection	1.5 Mbps @ 720p or 2.5 Mbps @1080p upload bandwidth per baby unit

OVERVIEW

Baby unit overview

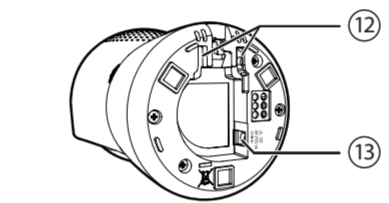
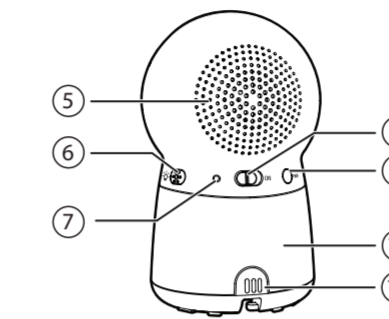
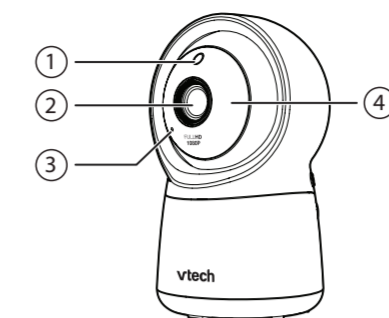

- Light sensor**
- Camera lens**
- Microphone**
- Infrared LEDs**
 - Allow you to see clearly in a dark surrounding.
- Speaker**
- LED indicator**
 - Press to turn the night light on or off.
- LED indicator**
 - Orange is steady on when the baby unit is connecting to the parent unit in direct mode.
 - Green is steady on when the baby unit and parent unit are connecting to your home Wi-Fi network via the Wi-Fi router.
 - Flashes orange slowly during video streaming in direct mode.
 - Flashes green slowly during video streaming via home Wi-Fi network.
- ON**
 - Power on/off switch.
- PAIR**
 - Press **and hold** for three seconds to enter pairing mode.
 - Reset the baby unit to factory default.
 - Press orange slowly **PAIR** key until you hear a beep sound.
 - Release the **PAIR** key, and then press the **PAIR** key again five times until you hear another beep sound.
 - The baby unit will sound another beep when the reset completes. Then, the baby unit will reboot.
- Night light**
- Temperature sensor**
- Slots for wall mounting**
 - Wall mount bracket is included in your package.
- Power jack**

Parent unit overview

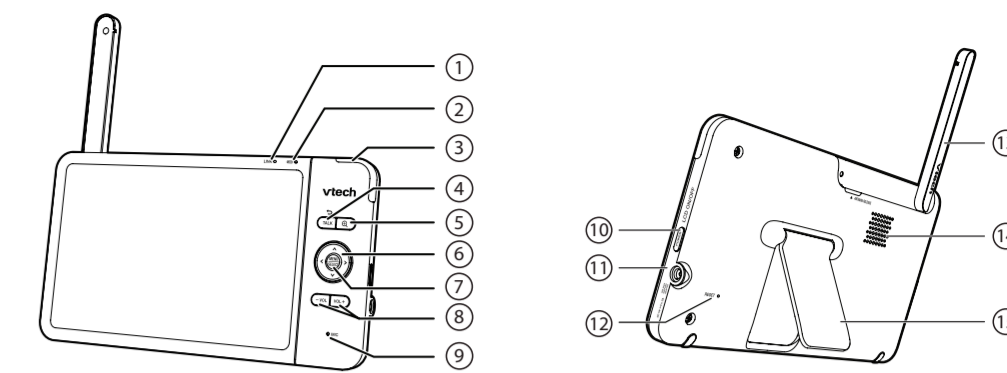

- LINK LED light**
 - On when the parent unit is linked to the baby unit.
 - Flashes when the link to the baby unit is lost.
- LINK LED light**
 - On when the parent unit is connected to AC power, and the battery is charging.
 - Off when the parent unit is disconnected from AC power, or when the parent unit is connected to AC power and the battery is fully-charged.
 - Flashes when the parent unit battery is low and needs charging.
- 3-level sound indicator light**
 - Green on when low sound level is detected by the baby unit.
 - Green and amber on when moderate sound level is detected by the baby unit.
 - Green, amber and red on when high sound level is detected by the baby unit.
- TALK**
 - Press **and hold** to talk to the baby unit.
 - While in a submenu, press to exit.
- Microphone**
- POWER / LCD ON/OFF**
 - Press **and hold** to power on or off.
 - Press to turn on or off the LCD screen.
- Power jack**
- RESET**
 - Force reboot the parent unit.
- Antenna**
- Speaker**
- Stand**

HOW THE SYSTEM WORKS

Direct mode

The parent unit and the baby unit of your video monitor connect to each others in **Direct mode** by default, which allows you to stream live video right out of the box. **Direct mode** connection lets you stream live video from parent unit only.

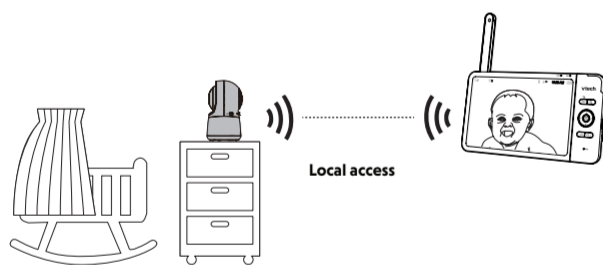

TIP

- You may experience reduced signal strength if your parent unit and baby unit are far apart, or there are obstructing factors, such as internal walls, between them. Move the parent unit closer to the baby unit to improve the signal strength. You can also set up **Router mode** to connect via your home Wi-Fi network to improve the connection between your parent unit and baby unit.

Router mode

You can continue using your video monitor with **Direct mode** connection, or you can set up your monitor in **Router mode** connection.

Router mode uses your home Wi-Fi network to connect your video monitor. It supports streaming live video through parent unit and smartphone app.

We recommend that you set up your monitor in **Router mode** to enjoy streaming live video via your parent unit with better connection.

If you want to stream live video remotely with your mobile device, download and install the **MyVTech Baby 1080p** mobile app. With the mobile app, your Wi-Fi router (not included) provides Internet connectivity to your HD video monitor system. It serves as a communicating channel between your baby unit and mobile device, allowing you to monitor and/or control your baby unit wherever you are. For detail, see **Download app for mobile access** section in this quick start guide.

NOTES

- When both parent unit and app are viewing the camera simultaneously, the video quality will be optimised to deliver the best possible viewing result.

CABLE MANAGEMENT

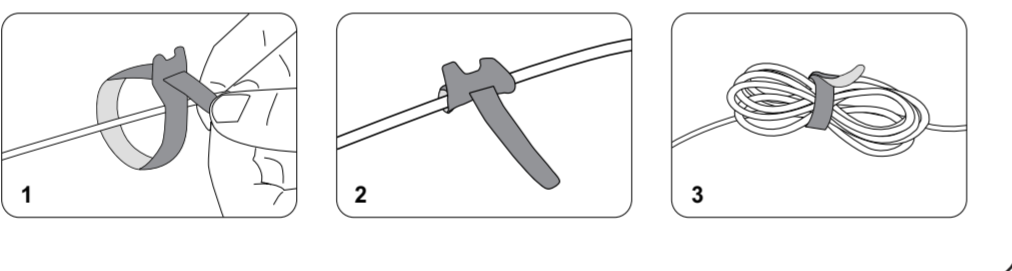

PROTECT YOUR PRIVACY AND ONLINE SECURITY

VTech cares about your privacy and peace of mind. That's why we've put together a list of industry-recommended best practices to help keep your wireless connection private and your devices protected when online. We recommend you carefully review and consider complying with the following tips.

- Ensure your wireless connection is secure.
- Before installing a device, ensure your router's wireless signal is encrypted by selecting the "WPA2-PSK with AES" setting in your router's wireless security menu.
- Change default settings.
- Change your wireless router's default wireless network name (SSID) to something unique.
 - Change default passwords to unique, strong passwords. A strong password:
 - Is at least 10 characters long.
 - Is complex.
 - Does not contain dictionary words or personal information.
 - Contains a mix of uppercase letters, lowercase letters, special characters and numbers.
- Keep your devices up to date.
- Download security patches from manufacturers as soon as they become available. This will ensure you always have the latest security updates.
 - If the feature is available, enable automatic updates for future releases.
- Disable Universal Plug and Play (UPnP) on your router.
- UPnP enabled on a router can limit the effectiveness of your firewall by allowing other network devices to open inbound ports without any intervention or approval from you. A virus or other malware program could use this function to compromise security for the entire network.

For more information on wireless connections and protecting your data, please review the following resources from industry experts:

- Federal Communications Commission: Wireless Connections and Bluetooth Security Tips – www.fcc.gov/consumers/guides/how-protect-yourself-online.
- U.S. Department of Homeland Security: Before You Connect a New Computer to the Internet – www.us-cert.gov/ncas/tips/ST15-003.
- Federal Trade Commission: Using IP Cameras Safely – <https://www.consumer.ftc.gov/articles/0382-using-ip-cameras-safely>.
- Wi-Fi Alliance: Discover Wi-Fi Security – <http://www.wi-fi.org/discover-wi-fi-security>.

CONNECT, CHARGE AND POWER ON THE BABY MONITOR

Connect the baby monitor

NOTES

- The rechargeable battery in the parent unit is built-in.
- Use only the power adapters supplied with this product.
- Make sure the parent unit and the baby unit are not connected to the switch controlled electric outlets.
- Connect the power adapters in a vertical or floor mount position only. The adapters' prongs are not designed to hold the weight of the parent unit and the baby unit, so do not connect them to any ceiling, under-the-table, or cabinet outlets. Otherwise, the adapters may not properly connect to the outlets.
- Make sure the parent unit, the baby unit and the power adapter cords are out of reach of children.

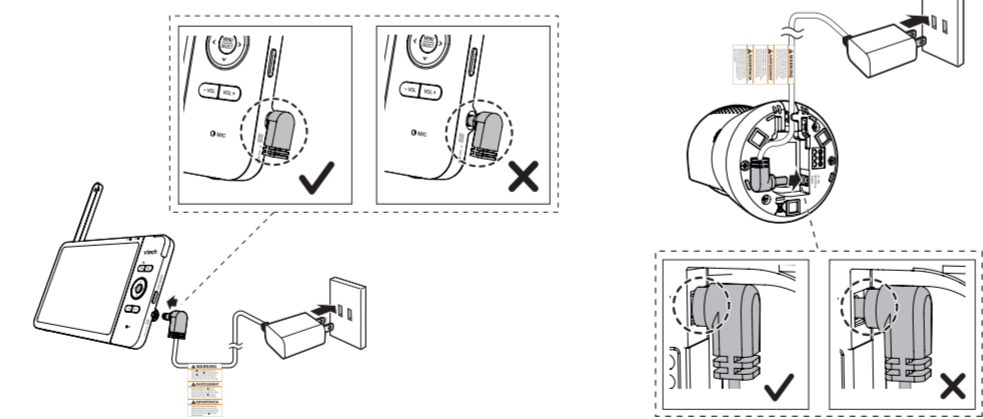

Slide the switch to **ON** to power on your baby unit.

NOTES

- When powering up, the baby unit's status LED turns on. It will turn off after a while and keeps off.
- The status LED is set to off by default. If you want to keep the LED on, press **MENU**, then go to **Status LED** and turn it on.

NOTE:
Camera lens and surface may get warm during normal operation.

Charge the parent unit battery before use

The parent unit runs on rechargeable battery or AC power. To continuously monitor your baby, keep the parent unit connected to AC power. With the battery alone, the parent unit can cordlessly run for a short time only.

NOTES

- Before using the baby monitor for the first time, charge the parent unit battery for 12 hours. When the parent unit battery is fully charged, the battery icon becomes solid.
- The standby time varies depending on your actual use.

After the parent unit is fully charged, press **POWER** until the welcoming screen appears.

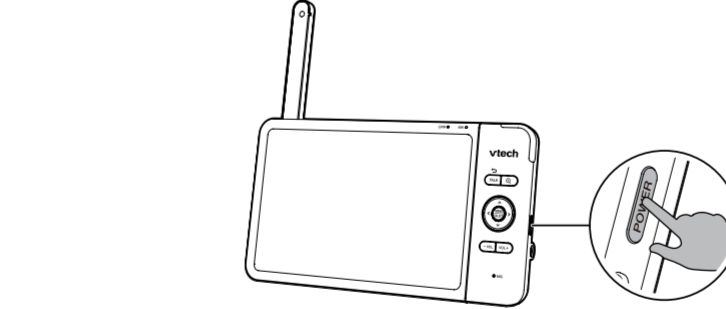

The battery icon indicates the battery status (see the following table).

BATTERY INDICATORS	BATTERY STATUS	ACTION
The screen displays and . The light flashes.	The battery has very little charge and may be used for only a short time.	Charge without interruption (about 30 minutes).
The battery icon becomes solid .	The battery is fully charged.	To keep the battery charged, connect it to AC power when not in use.

Raise the parent unit antenna for better reception

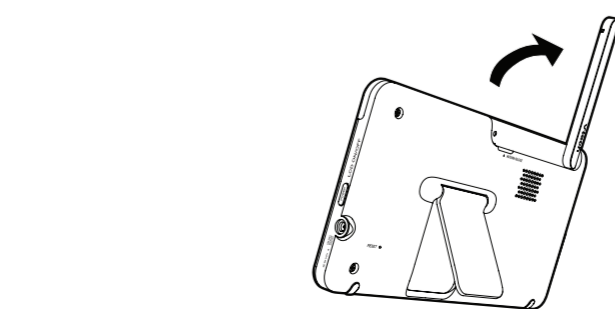

PARENT UNIT ICONS

Main Menu	Options	Main Menu	Options
Monitoring mode (For RM7754-2HD only)	<ul style="list-style-type: none"> View baby unit 1 or 2 in Single mode. View both baby units in Patrol mode. View both baby units in Split screen. 	General settings	<ul style="list-style-type: none"> Connect to home Wi-Fi network. Turn on/off Parent unit Wi-Fi Connection. Connect mobile phone.
Night light	<ul style="list-style-type: none"> Select color 1, 2 or 3. Turn off night light. 	Status icons	<ul style="list-style-type: none"> Direct mode Parent unit, baby unit 1 and baby unit 2 (For RM7754-2HD only) are connected to each others directly. Router mode Parent unit, baby unit 1 and baby unit 2 (For RM7754-2HD only) are connected to home Wi-Fi network. Baby unit 1 and 2 are being viewed in Patrol mode (For RM7754-2HD only). Baby unit 1 and 2 are being viewed in Split mode (For RM7754-2HD only). Night vision is turned on. Motion alert is turned on. Sound detection alert is turned on. Melodies and soothing sounds are turned on. Night light is turned on. Parent unit speaker is muted. Temperature alert is turned on.
Melodies and soothing sounds	<ul style="list-style-type: none"> Select play all melodies, or play one of the five melodies and four soothing sounds. You can also set the timer to stop playing after 15, 30 or 60 minutes, or playing non-stop. 	Alerts - Sound, motion and temperature	<ul style="list-style-type: none"> Select the sound and motion sensitivity level. Turn on/off sound and motion detection alerts. Select maximum and minimum temperature for alert range. Turn on/off temperature alert. Turn on/off Auto Wake Up function.
Parent unit settings	<ul style="list-style-type: none"> Adjust parent unit screen brightness. Turn on/off Low Battery Alert Tone. Turn on/off No Link Alert Tone. Turn on/off dim mode. 	Baby unit settings	<ul style="list-style-type: none"> Turn on/off Night Vision. Turn on/off baby unit's status LED. Adjust baby unit's speaker volume. Update baby unit's security key.

BASIC OPERATION

After powering up your video monitor, the parent unit streams live video in direct mode. We recommend you follow the instructions on screen to set up home Wi-Fi network with your monitor for functionality enhancements and mobile access. See **Auto software and firmware update** and **Download app for mobile access** in this quick start guide.

Use the menu

Press **MENU** on the parent unit to enter the main menu, choose a menu item, or save a setting. You can use the parent unit menu for advanced settings or operations, such as to play or stop lullaby, or adjust the motion and sound detection settings.

While in the menu:

- Press **▲**, **▼**, **<** or **>** to scroll among the menu options.
- Press **SELECT** to select an item.
- Press **TALK** to return to the live video.
- Press **ⓘ** to go to the **Help & info** page.

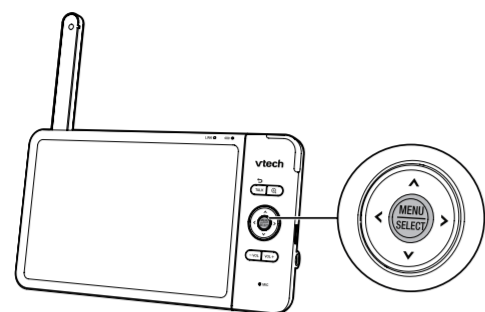

Adjust speaker volume

Press **-VOL / VOL+** to adjust your parent unit speaker volume. It determines the volume of sound transmitted from your baby unit.

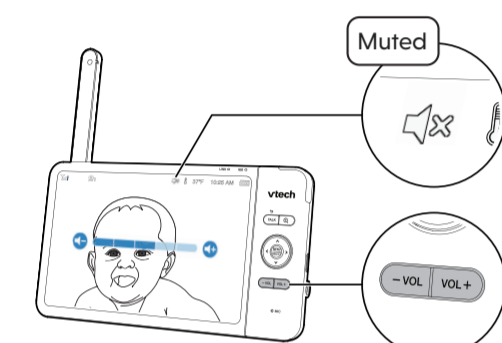

Zoom

Press **Q** to zoom in or out.



Talk to your baby via the baby unit

- Press and hold the **TALK** key.
- When the **TALK** icon displays on screen, speak to your parent unit. Your voice is transmitted to the baby unit.
- When finished talking, release the **TALK** key to hear your baby again.

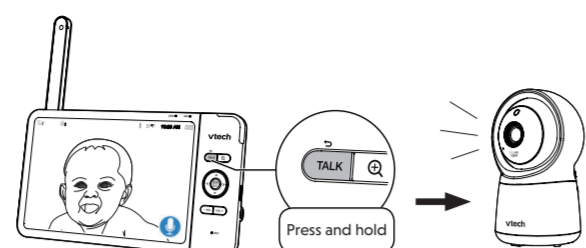

Turn on/off baby unit's status LED

You may set the status LED indicator of your baby unit on or off. Go to

STATUS LED.

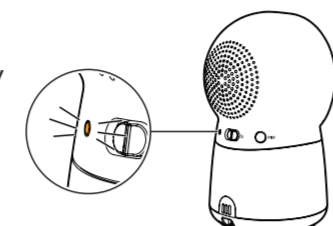

Turn on/off the parent unit screen

You can turn on or off the parent unit screen without powering off the parent unit. You can still hear sound from the baby unit.

- Press **POWER** on the parent unit to turn off the screen.
- Press any keys on the parent unit to turn on the screen again.

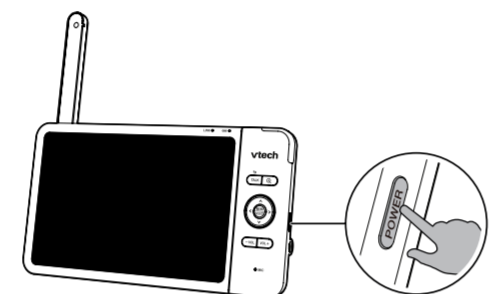

TIP

You can reset the parent unit by pressing the **RESET** key at the back of the unit.

Use a pin and insert it into the hole on the back of the parent unit, and then press the button inside.

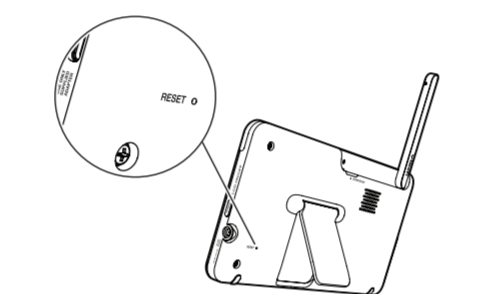

TEST THE SOUND LEVEL AND POSITION THE HD VIDEO MONITOR

NOTE

- This HD video monitor is intended as an aid. It is not a substitute for proper adult supervision, and should not be used as such.

Testing the sound level of the HD video monitor

CAUTION

- For hearing protection, make sure the parent unit is more than 3 metres away from the baby unit. If you hear any feedback noise from the parent unit, move the parent unit further until the noise stops. You can also press **-VOL** on the parent unit to lower or mute the noise.

TIP

- Increase the parent unit speaker volume if you cannot hear the sounds transmitted from the baby unit.

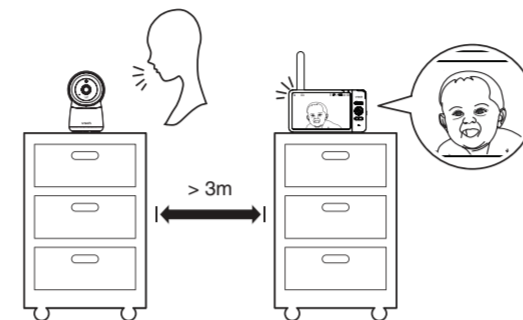

Positioning the HD video monitor

CAUTION

- Keep the baby unit out of the reach of your baby. Never place or mount the baby unit inside the baby's crib or playpen.

- Place the baby unit more than 1 metre away from your baby.

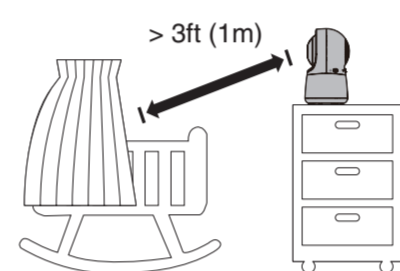

- Adjust the angle of the baby unit to aim at your baby.

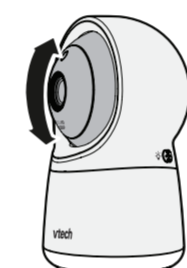

- To avoid causing feedback noise from your HD video monitor:

- Make sure your baby unit and parent unit are more than 3 metres apart; OR
- Turn down the volume of your parent unit.

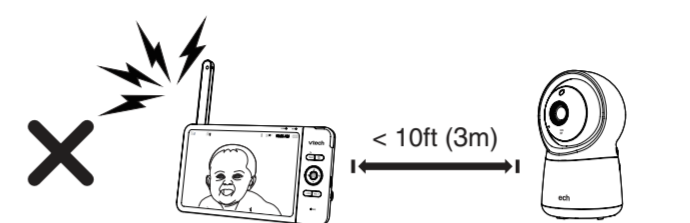
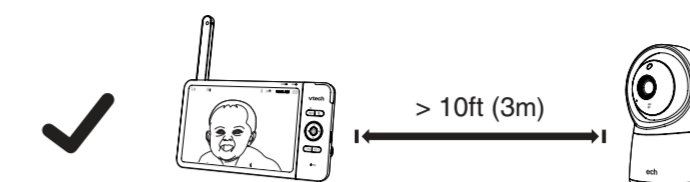

AUTO SOFTWARE AND FIRMWARE UPDATE

To ensure that your HD video monitor is always at its best performance, the parent unit will prompt a message and ask you to update its software and the baby unit's firmware when there are new versions available.

- Follow the instructions on the parent unit screen to update your HD video monitor. If you skip the updates, the parent unit and baby unit will be updated automatically when the parent unit is powered off, and then powered on again.

Connect your HD video monitor with home Wi-Fi network

- You must connect your video monitor to your secured home Wi-Fi network in order to receive the latest software and firmware updates. To set it up, go to

CONFIGURE WI-FI.

TEST THE LOCATION FOR THE BABY UNIT

If you plan to install your baby unit in a designated location, and use your home Wi-Fi network to connect your video monitor, you need to test which of your selected monitoring areas within the house have good Wi-Fi signal strength. After you have powered on your parent unit, you can use your parent unit's Wi-Fi signal strength indicator to assist in checking. Once you have identified the suitable location, you can install your baby unit. Adjust the distance between your baby unit and the Wi-Fi router if needed.

TIP

- Depending on surroundings and obstructing factors, such as the effect distance and internal walls have on signal strength, you may experience reduced Wi-Fi signal. To improve the Wi-Fi signal strength, adjust the distance or direction of your parent unit. Check with your parent unit again.

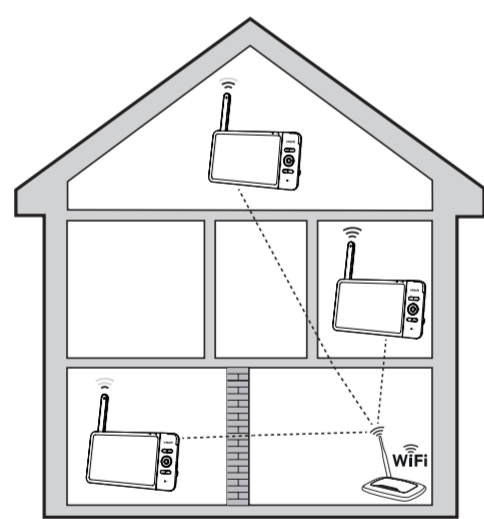

MOUNT THE BABY UNIT (OPTIONAL)

NOTES

- Check for reception strength and camera angle of the baby unit before drilling the holes.
- The types of screws and anchors you need depend on the composition of the wall. You may need to purchase the screws and anchors separately to mount your baby units.

- Place the wall mount bracket on a wall and then use a pencil to mark two holes in parallel. Remove the wall mount bracket and drill two holes in the wall (7/32 inch drill bit).

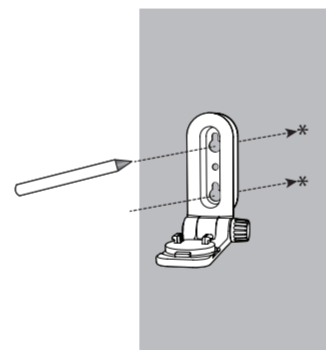

- If you drill the holes into a stud, go to step 3.
- If you drill the holes into an object other than a stud, insert the wall anchors into the holes. Tap gently on the ends with a hammer until the wall anchors are flush with the wall.



- Align the wall mount bracket and screws with the holes in the wall as shown. Tighten the screw in the middle hole first, so that the wall mount bracket position is fixed. You can tighten the other screw in the top hole.

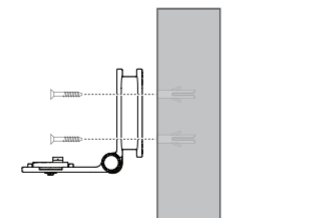

- Insert the screws into the holes and tighten the screws until only 1/4 inch of the screws are exposed.

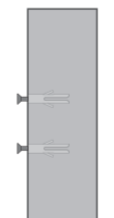

- Place the baby unit on the wall mount bracket, and then slide it forward until it locks into place. Connect the power adaptor to the baby unit and a power supply.

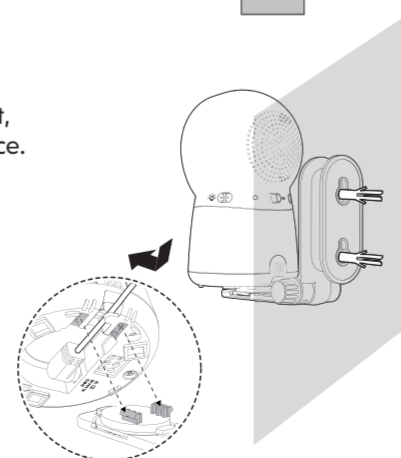

OR

- Place the baby unit on the wall mount bracket, and then slide it forward until it locks into place. Align the holes on the wall mount bracket with the screws on the wall, and slide the wall mount bracket down until it locks into place.

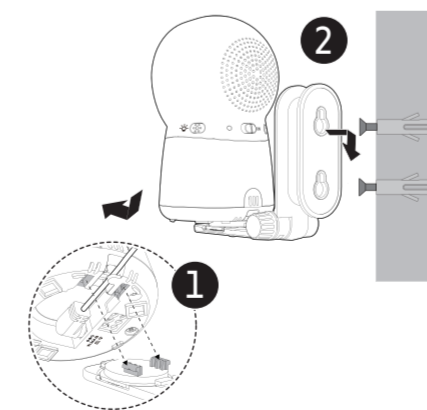

- You can maximize your baby unit's viewing angles by tilting the wall mount bracket. Hold the baby unit, and then rotate the knob in an anticlockwise direction. This will loosen the joint of the wall mount bracket. Tilt your baby unit up or down to adjust to your preferred angle. Then, rotate the knob in a clockwise direction to tighten the joint and secure the angle.

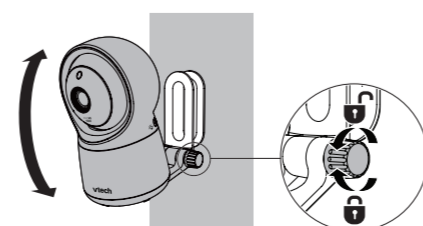

LIMITED WARRANTY

What does this limited warranty cover?

The manufacturer of this VTECH Product warrants to the holder of a valid proof of purchase ("Consumer" or "you") that the Product and all accessories provided in the sales package ("Product") are free from defects in material and workmanship, pursuant to the following terms and conditions, when installed and used normally and in accordance with the Product operating instructions. This limited warranty extends only to the Consumer for Products purchased and used in the United States of America and Canada.

What will VTECH do if the Product is not free from defects in materials and workmanship during the limited warranty period ("Materially Defective Product")?

During the limited warranty period, VTECH's authorized service representative will repair or replace at VTECH's option, without charge, a Materially Defective Product. If we repair the Product, we may use new or refurbished replacement parts. If we choose to replace the Product, we may replace it with a new or refurbished Product of the same or similar design. We will retain defective parts, modules, or equipment. Repair or replacement of the Product, at VTECH's option, is your exclusive remedy. VTECH will return the repaired or replacement Product to you in working condition. You should expect the repair or replacement to take approximately 30 days.

How long is the limited warranty period?

The limited warranty period for the Product extends for ONE (1) YEAR from the date of purchase. If VTECH repairs or replaces a Materially Defective Product under the terms of this limited warranty, this limited warranty also applies to the repaired or replacement Product for a period of either (a) 90 days from the date the repaired or replacement Product is shipped to you or (b) the time remaining on the original one-year warranty; whichever is longer.

What is not covered by this limited warranty?

This limited warranty does not cover:

- Product that has been subjected to misuse, accident, shipping or other physical damage, improper installation, abnormal operation or handling, neglect, inundation, fire, water or other liquid intrusion; or
- Product that has been damaged due to repair, alteration or modification by anyone other than an authorized service representative of VTECH; or
- Product to the extent that the problem experienced is caused by signal conditions, network reliability, or cable or antenna systems; or
- Product to the extent that the problem is caused by use with non-VTECH accessories; or
- Product whose warranty/quality stickers, product serial number plates or electronic serial numbers have been removed, altered or rendered illegible; or
- Product purchased, used, or shipped for repair from outside the United States of America or Canada, or used for commercial or institutional purposes (including but not limited to Products used for rental purposes); or
- Product returned without a valid proof of purchase (see item 2 on the following part); or
- Charges for installation or set up, adjustment of customer controls, and installation or repair of systems outside the unit.

How do you get warranty service?

To obtain warranty service in Canada, please visit our website at www.vtechcanada.com or call 1-888-211-2005. NOTE: Before calling for service, please review the user's manual - a check of the Product's controls and features may save you a service call.

Except as provided by applicable law, you assume the risk of loss or damage during transit and transportation and are responsible for delivery or handling charges incurred in the transport of the Product(s) to the service location. VTECH will return repaired or replaced Product under this limited warranty. Transportation, delivery or handling charges are prepaid. VTECH assumes no risk for damage or loss of the Product in transit. If the Product failure is not covered by this limited warranty, or proof of purchase does not meet the terms of this limited warranty, VTECH will notify you and will request that you authorize the cost of repair prior to any further repair activity. You must pay for the cost of repair and return shipping costs for the repair of Products that are not covered by this limited warranty.

What must you return with the Product to get warranty service?

- Return the entire original package and contents including the Product to the VTECH service location along with a description of the malfunction or difficulty; and
- Include a "valid proof of purchase" (sales receipt) identifying the Product purchased (Product model) and the date of purchase or receipt; and
- Provide your name, complete and correct mailing address, and telephone number.

Other limitations

This warranty is the complete and exclusive agreement between you and VTECH. It supersedes all other written or oral communications related to this Product. VTECH provides no other warranties for this Product. The warranty exclusively describes all of VTECH's responsibilities regarding the Product. There are no other express warranties. No one is authorized to make modifications to this limited warranty and you should not rely on any such modification. State/Provincial Law Rights: This warranty gives you specific legal rights, and you may also have other rights, which vary from state to state or province to province.

Limitations: Implied warranties, including those of fitness for a particular purpose and merchantability (an unwritten warranty that the Product is fit for ordinary use) are limited to one year from the date of purchase. Some states/provinces do not allow limitations on how long an implied warranty lasts, so the above limitation may not apply to you. In no event shall VTECH be liable for any indirect, special, incidental, consequential, or similar damages (including, but not limited to lost profits or revenue, inability to use the Product or other associated equipment, the cost of substitute equipment, and claims by third parties) resulting from the use of this Product. Some states/provinces do not allow the exclusion or limitation of incidental or consequential damages, so the above limitation or exclusion may not apply to you.

Please retain your original sales receipt as proof of purchase.

DOWNLOAD APP FOR MOBILE ACCESS

- Download the free **MyVTECH Baby Pro** mobile app and install it to a mobile device, then use your mobile device and the mobile app to monitor your areas remotely.



- Press **MENU** when the parent unit is idle.
- Go to **CONNECT MOBILE PHONE**.
- Scan the QR code in the parent unit to download the app into your mobile device.
- Follow the instructions in the mobile app to set up and pair your baby unit to the mobile app.

Alternatively, you can download the mobile app from the App Store or Google Play store.

Install MyVTECH Baby Pro mobile app

- Browse the App Store or the Google Play store.
- Search for the mobile app with the keyword "myvtech baby pro".
- Download and install the **MyVTECH Baby Pro** mobile app to your mobile device.

OR

Scan the QR codes on the right to get the app.

NOTE

- Make sure your mobile device meets the minimum requirement for the mobile app.

Minimum requirement

The mobile app is compatible with:

- Android™ 6.0 or later; and
- iOS 12 or later.

- After installing the mobile app, follow the instructions in the mobile app and parent unit to set up and pair your baby unit.

In your mobile device:

- Tap **Run** to run the mobile app in your mobile device, and then create a user account.
- We recommend that you use common webmail services, such as Google Gmail for registration of your user account. Check your email (and Spam folder), and activate your new camera account via the email link, then sign in to your account.
- Follow the instructions in the mobile app to pair the camera. Tap **Add Camera**, then **Add Camera** in the mobile app to get started.



NEED HELP?

Driven by system updates, the software, online help topics, and online FAQs will be updated periodically.

For operations and guides to help you using your HD video monitor, and for latest information and supports, go and check the online help topics and online FAQs.

Use your smartphone or mobile device to access our online help.

- Go to <https://phones.vtechcanada.com/manuals>; OR Scan the QR code on the right. Launch the camera app or QR code scanner app on your smartphone or tablet. Hold the device's camera up to the QR code and frame it. Tap the notification to trigger the redirection of the online help.

- If the QR code is not clearly displayed, adjust your camera's focus by moving your device closer or further away until it is clear.

- Search for the model - **RM7754HD** or **RM7754-2HD**.

You can also call our Customer Support at 1-888-211-2005 for help.



Android™ and Google Play™ are trademarks of Google Inc.
App Store is a trademark of Apple Inc., registered in the U.S. and other countries.
iOS is a trademark or registered trademark of Cisco in the U.S. and other countries and is used under license.



Specifications are subject to change without notice.
© 2024 VTECH Technologies Canada Ltd.
All rights reserved. 04/24. RM7754-XHD_CA_OSG_V3

